

audison

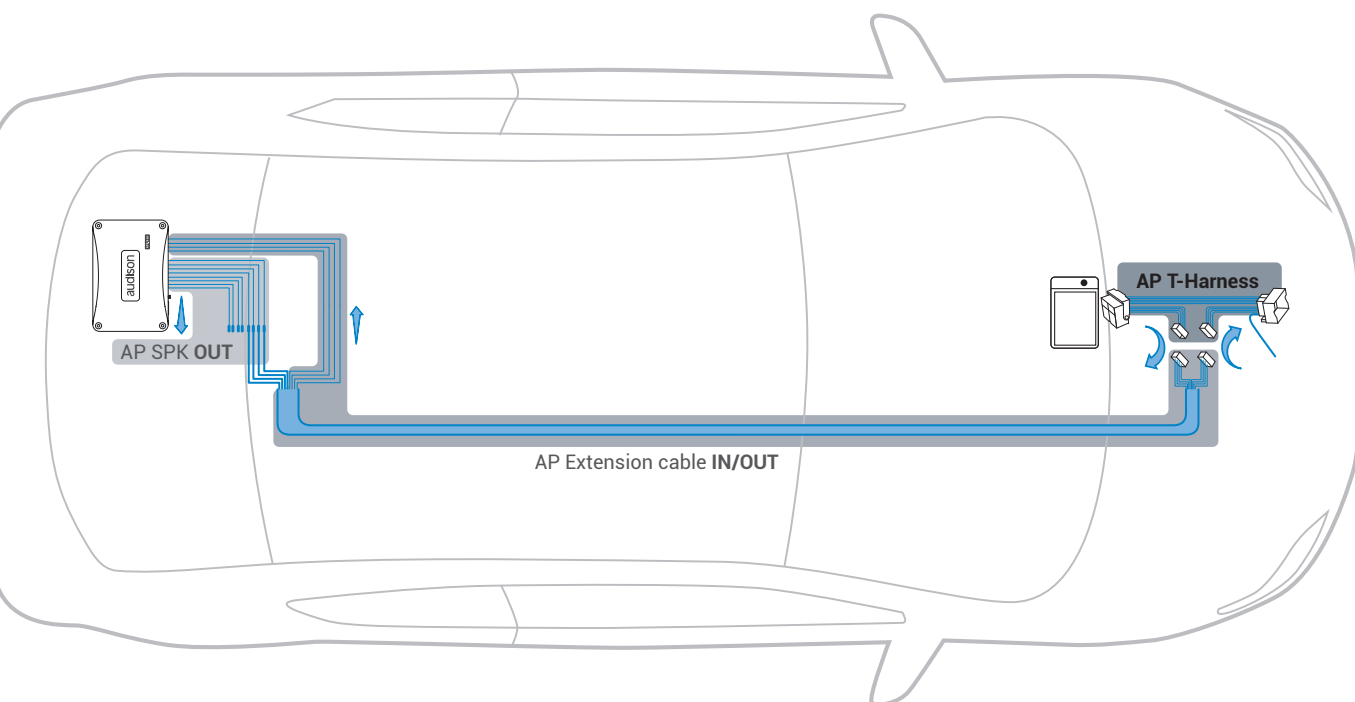

prima

PRODUCT INFORMATION P&P CABLE

Elettromedia May 2018



www.audison.eu



ideato,
progettato,
ingegnerizzato
in Italia

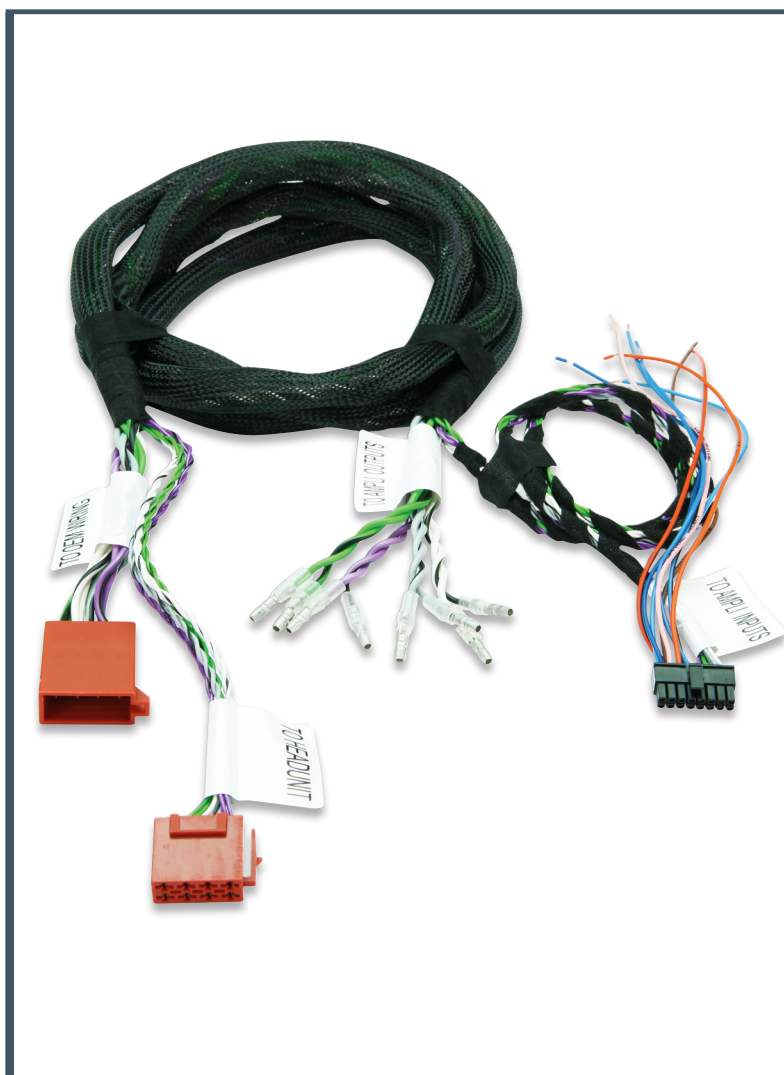

Product Information

Elettromedia - May 2018

Prima AP Plug&Play cables	3
Technical Sheet	5
AP Plug & Play cables:	
AP8.9 bit Outputs config. sheet: 2 Way active Front + Rear + Sub	8
AP5.9 bit Outputs config. sheet: 2 Way active Front + Sub	10
AP4.9 bit Outputs config. sheet: Front + Rear	12
Technical Specification	14
About us	30
Press kit	31

audison

For more information visit www.audison.eu

Prima AP Plug&Play cables

The Prima AP Plug&Play cables for the AP bit amplifiers ensure maximum ease of installation for the Audison Prima system according to the "OEM Integrator" philosophy. For this purpose, cables with Plug&Play connections and foolproof have been built using the same materials employed to build the OEM wiring.

The solutions which Audison offers are: AP T-Harness "DCC", AP Extension Cables and AP Speakers Output Cables.

Thanks to these three cable families, the AP bit amplifiers can be installed on a large number of vehicles with drastically reduced working time, and without the need to modify the factory wiring.

All cables have appropriate gauge size and are twisted to ensure maximum shielding effectiveness along the entire input/output line.

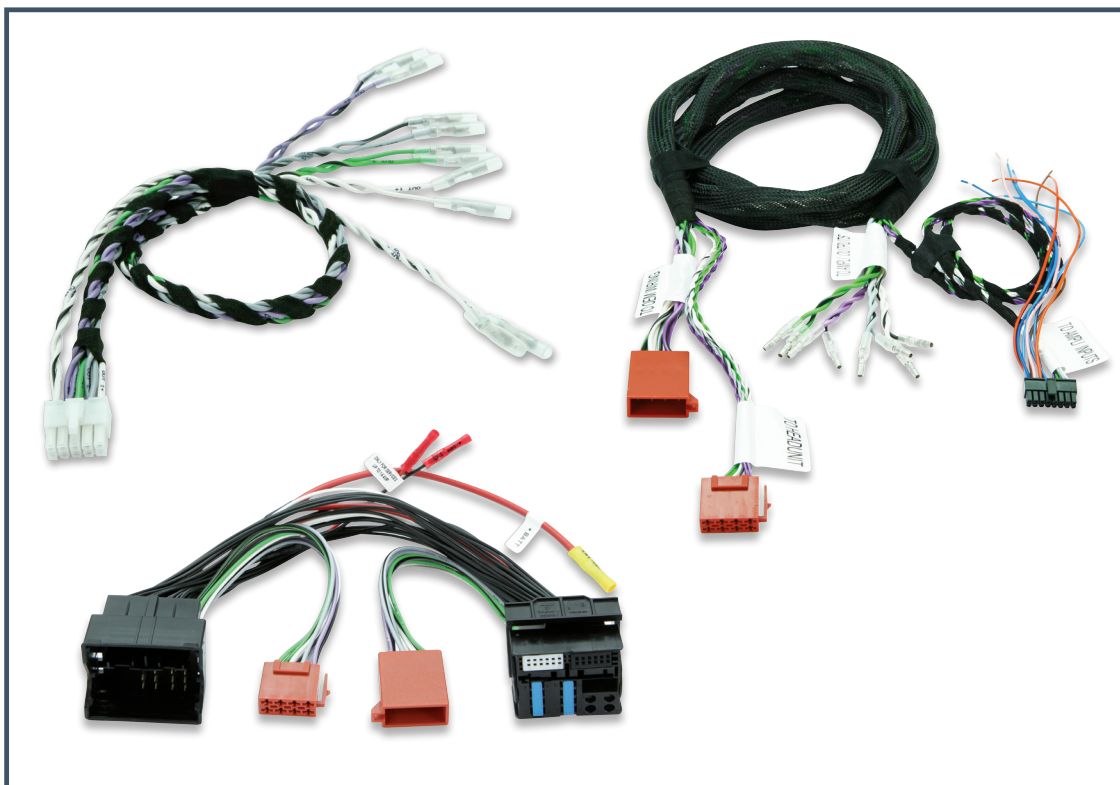

AP T-Harness "DCC".

T-Harness "DCC" is the Plug&Play solution to integrate Audison Prima with the factory car audio system. The battery positive is taken from the head unit without the need of reaching the engine compartment thanks to the DCC* solution.

*The DCC solution, (Direct Cockpit Current) can be used combined with the AP bit amplifiers' feature which controls the amplifier absorption peaks, protecting the car power supply system.

AP Extension cables.

The Extension cable with Plug&Play connections allows total freedom in positioning the AP bit amplifiers. Two extension typologies are available: input only, to only send the audio signal coming from the head unit to the AP bit amplifiers, or input/output, transmit also the AP bit amplifiers' output signal to the factory audio system. To do so, the AP Extension Cables IN/OUT needs to be installed together with the AP Speakers Output Cables (see following paragraph).

By use of the input/output extension, the installer is free to choose which configuration to adopt. Actually, thanks to the AP Extension cables, each single channel of the AP bit amplifier is sent to any of the speakers in the car, so the installer is free to carry out the desired configuration.

For example: standard front (2ch TW+WF), multi-amplified front (2ch TW + 2ch WF), multi-amplified front with 4 bridged channels (130W @ 4ohm) for the woofers (2ch TW + 4ch bridge WF) and all the other possible combinations.

AP Speakers Output cables.

The AP Speakers Output cables are available in 3 versions: for AP8.9 bit, for AP5.9 bit and for AP4.9 bit. These cables are dedicated to the connection of the AP bit amplifiers with the input/output Extension cable. The Plug&Play connectors with circle terminals are numbered ("CH1 +", CH1 -, etc...) for a foolproof connection. There is no need to solder any cable.

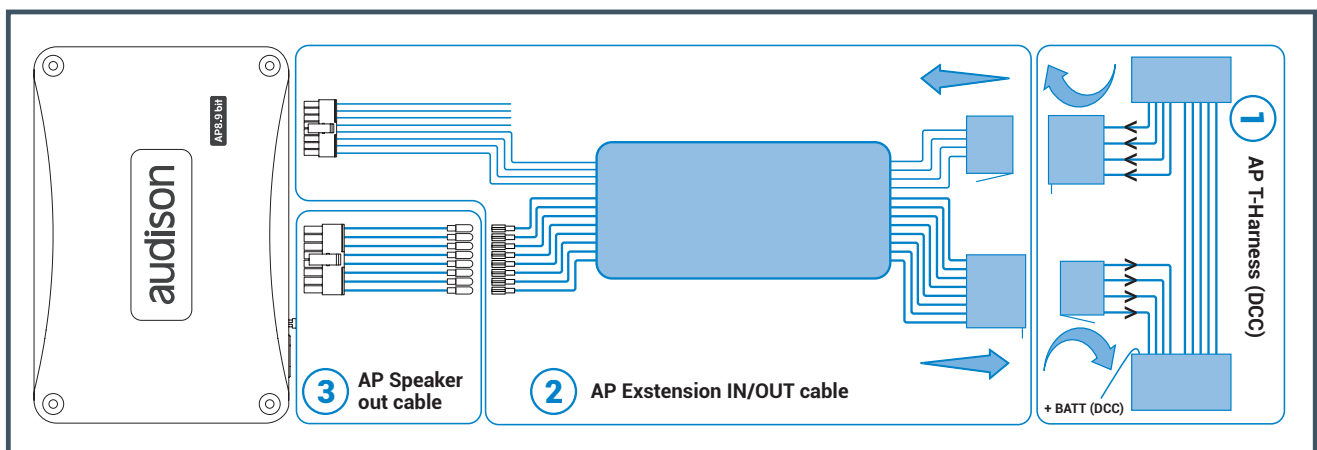

AP Extension cable In/Out.

- 1 Built with twisted cables, for effective elimination of disturbances.
- 2 Three different lengths (1,6 mt, 2,6 mt and 5,6 mt) suitable for any vehicle.
- 3 Cut-proof protective shield.
- 4 High flexibility for maximum ease of installation.
- 5 In/Out double connector, to also receive the amplified signal of the AP bit amplifiers.
- 6 No soldering required.

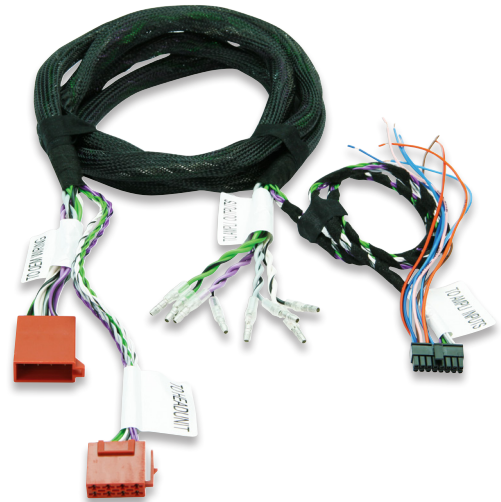

ITEM	DESCRIPTION
AP 160P&P I/O	ISO EXTENTION IN/OUT 160 cm/63"
AP 260P&P I/O	ISO EXTENTION IN/OUT 260 cm/102"
AP 560P&P I/O	ISO EXTENTION IN/OUT 560 cm/220"

AP Extension cable Input.

- 1 Built with twisted cables, for effective elimination of disturbances.
- 2 Three different lengths (1,6 mt, 2,6 mt and 5,6 mt) suitable for any vehicle.
- 3 Cut-proof protective shield.
- 4 High flexibility for maximum ease of installation.
- 5 No soldering required.

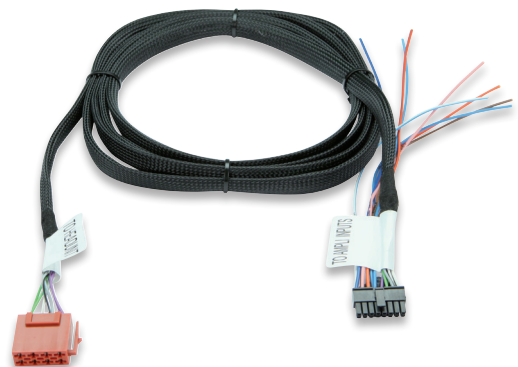

ITEM	DESCRIPTION
AP 160P&P IN	ISO EXTENTION INPUT 160 cm/63"
AP 260P&P IN	ISO EXTENTION INPUT 260 cm/102"
AP 560P&P IN	ISO EXTENTION INPUT 560 cm/220"

AP Speakers Output cables.

- 1 Built with twisted cables, for effective elimination of disturbances.
- 2 3 specific models dedicated to AP8.9 bit, AP5.9 bit and AP4.9 bit amplifiers respectively.
- 3 Round terminals for maximum ease of connection.
- 4 Multi-amplification possible with all configurations*.
- 5 Cables are numbered for foolproof connection to the Extension cable.
- 6 No soldering required.

*See connection diagrams

ITEM	DESCRIPTION
AP SPK OUT 4.9	4CH OUTS CIRC. TERMINALS FEMALE



ITEM	DESCRIPTION
AP SPK OUT 5.9	5CH OUTS CIRC. TERMINALS FEMALE



ITEM	DESCRIPTION
AP SPK OUT 8.9	8CH OUTS CIRC. TERMINALS FEMALE



AP T-Harness.

- 1 Designed specifically for your vehicle, for maximum OEM integration.
- 2 Connection to the AP Extension cable through ISO connectors.
- 3 Possibility to supply power to the amplifier via the direct cockpit current system, without the need of routing the cable through the engine compartment (with Audison Prima DCC solution).
- 4 ACC wire to re-launch ignition key signal to turn on / off an external device*.

*In those vehicles featuring ignition key connection wire (ACC wire), see compatibility list.

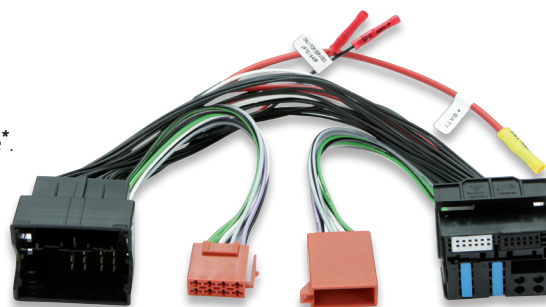

ITEM	DESCRIPTION
AP T-H BMW01	PRIMA T-HARNESS BMW
AP T-H AVS01	PRIMA T-HARNESS AUDI, VW 40PIN
AP T-H AVS02	PRIMA T-HARNESS AUDI, VW 52PIN
AP T-H TOL01	PRIMA T-HARNESS TOYOTA, LEXUS
AP T-H HON01	PRIMA T-HARNESS HONDA
AP T-H ISO01	PRIMA T-HARNESS ISO
AP T-H MBP01	PRIMA T-HARNESS MB, PORSCHE
AP T-H INI01	PRIMA T-HARNESS NISSAN/INFINITI
AP T-H CHR01	PRIMA T-HARNESS CHRYSLER 2007 ->
AP T-H FCA01	PRIMA T-HARNESS FIAT/CHRYSLER
AP T-H GMN01	PRIMA T-HARNESS GM 2009 ->
AP T-H FRD01	PRIMA T-HARNESS FORD 2002 ->
AP T-H GMO01	PRIMA T-HARNESS GM 2006 ->
AP T-H MAZ01	PRIMA T-HARNESS MAZDA 2001 ->

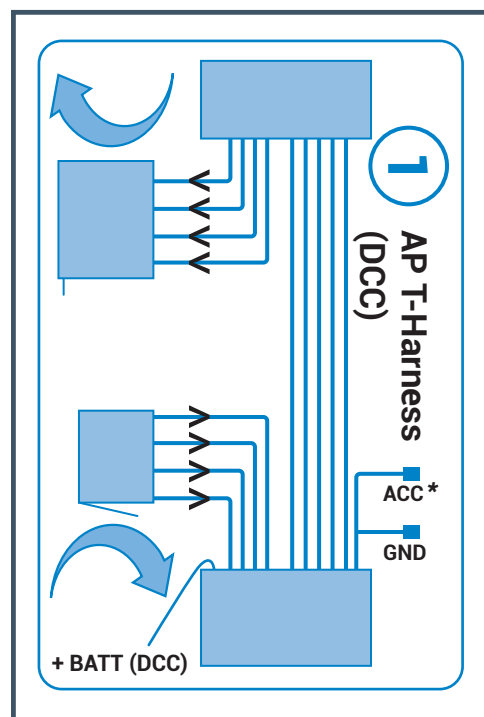

AP8.9 bit - Output configuration sheet - 2 way active Front + Rear + Sub (bridge)

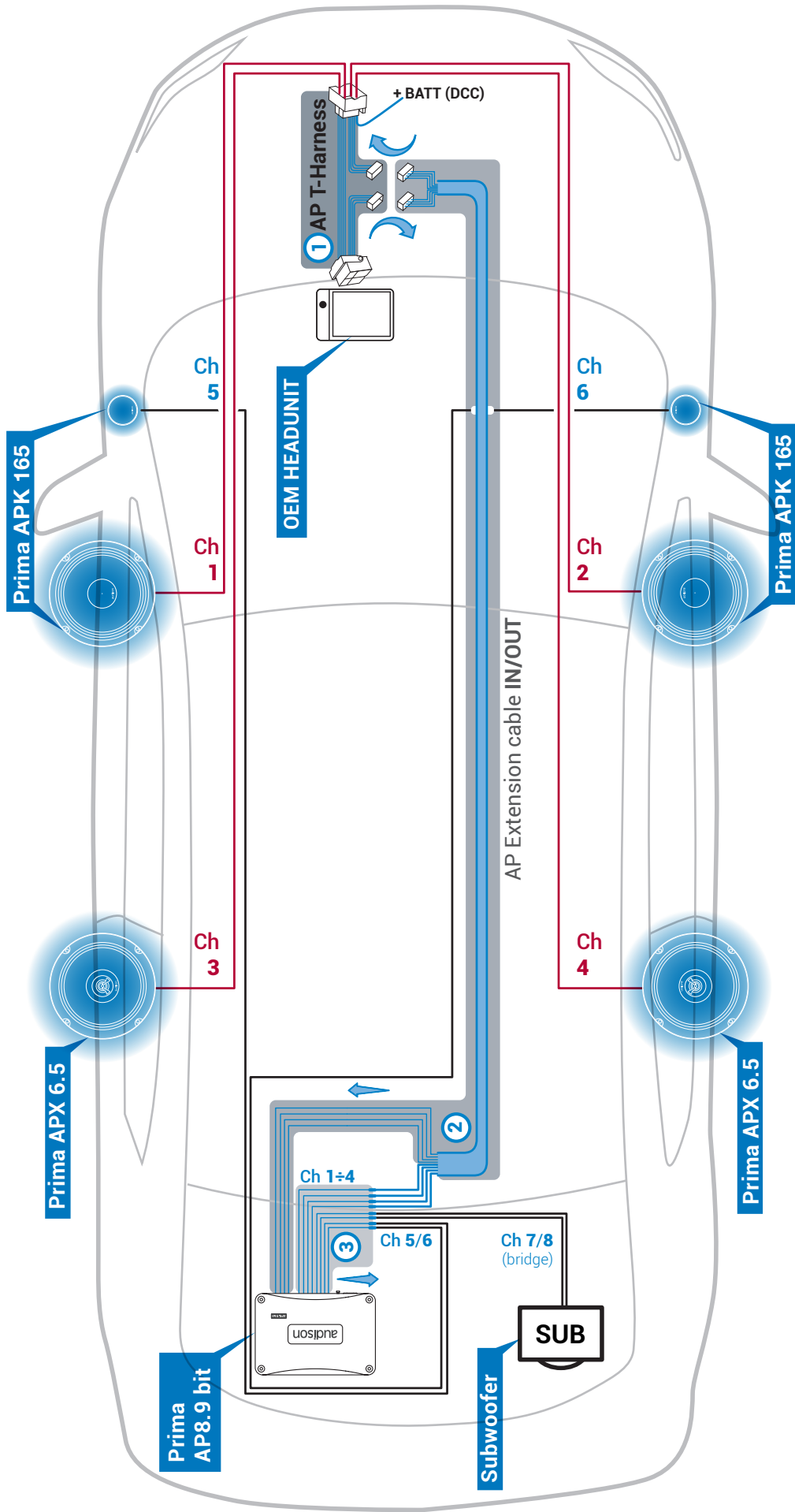

Legend

- █ AP Plug & Play cable
- █ OEM cable
- █ After market cable

All specifications subject to change without notice. 18A

POWER CHANNEL CONFIGURATION

STEREO MODE		BRIDGE MODE
CH1 35 W @ 4 Ohm / 65 W @ 2 Ohm	CH3 35 W @ 4 Ohm / 65 W @ 2 Ohm	CH5 35 W @ 4 Ohm / 65 W @ 2 Ohm
CH2 35 W @ 4 Ohm / 65 W @ 2 Ohm	CH4 35 W @ 4 Ohm / 65 W @ 2 Ohm	CH6 35 W @ 4 Ohm / 65 W @ 2 Ohm
		CH7+ / CH8- 130 W @ 4 Ohm

AP8.9 bit - Output configuration sheet - 2 way active Front + Rear + Sub (bridge)

Detailed View

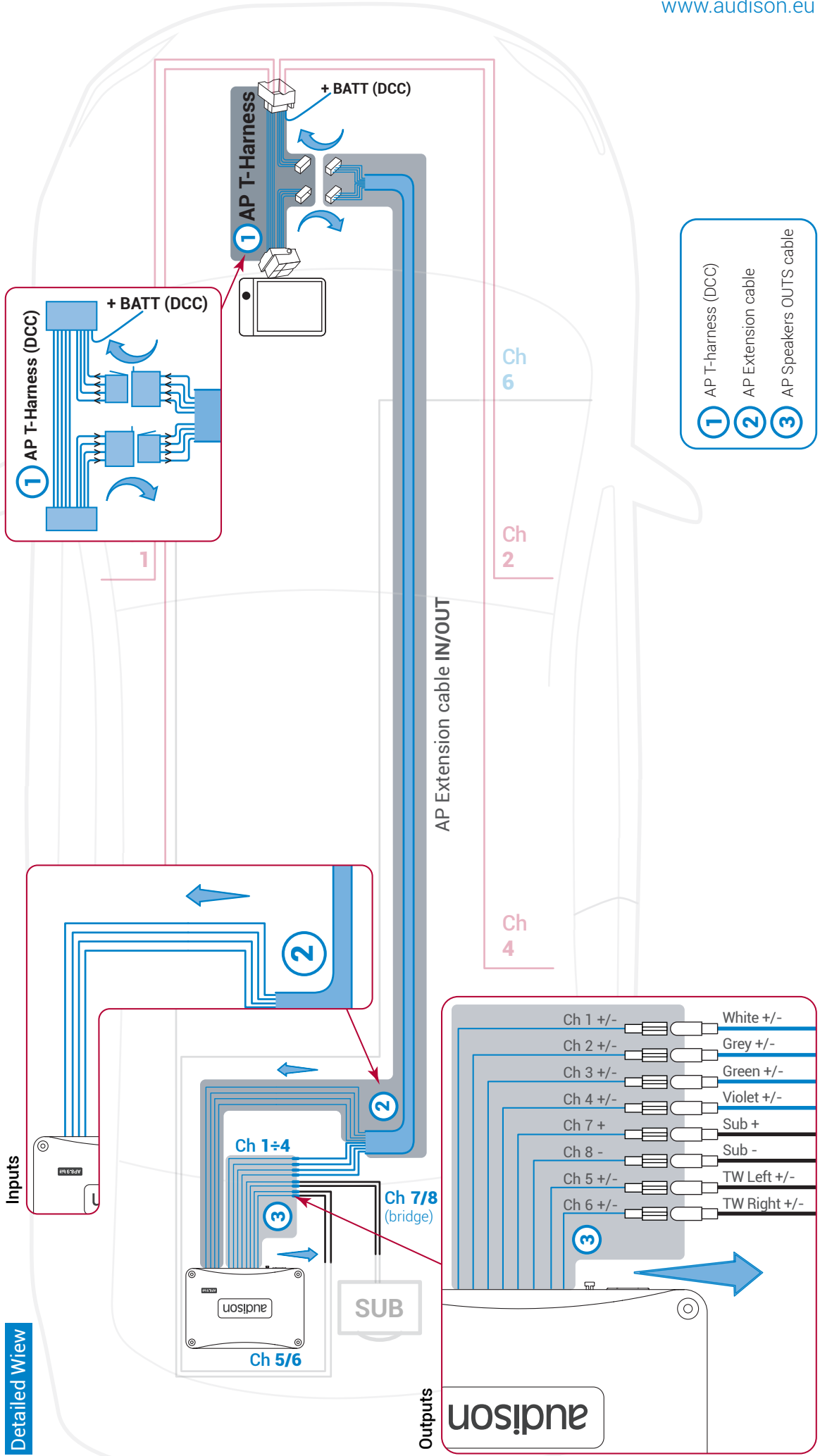

AP5.9 bit - Output configuration sheet - 2 way active Front + Sub

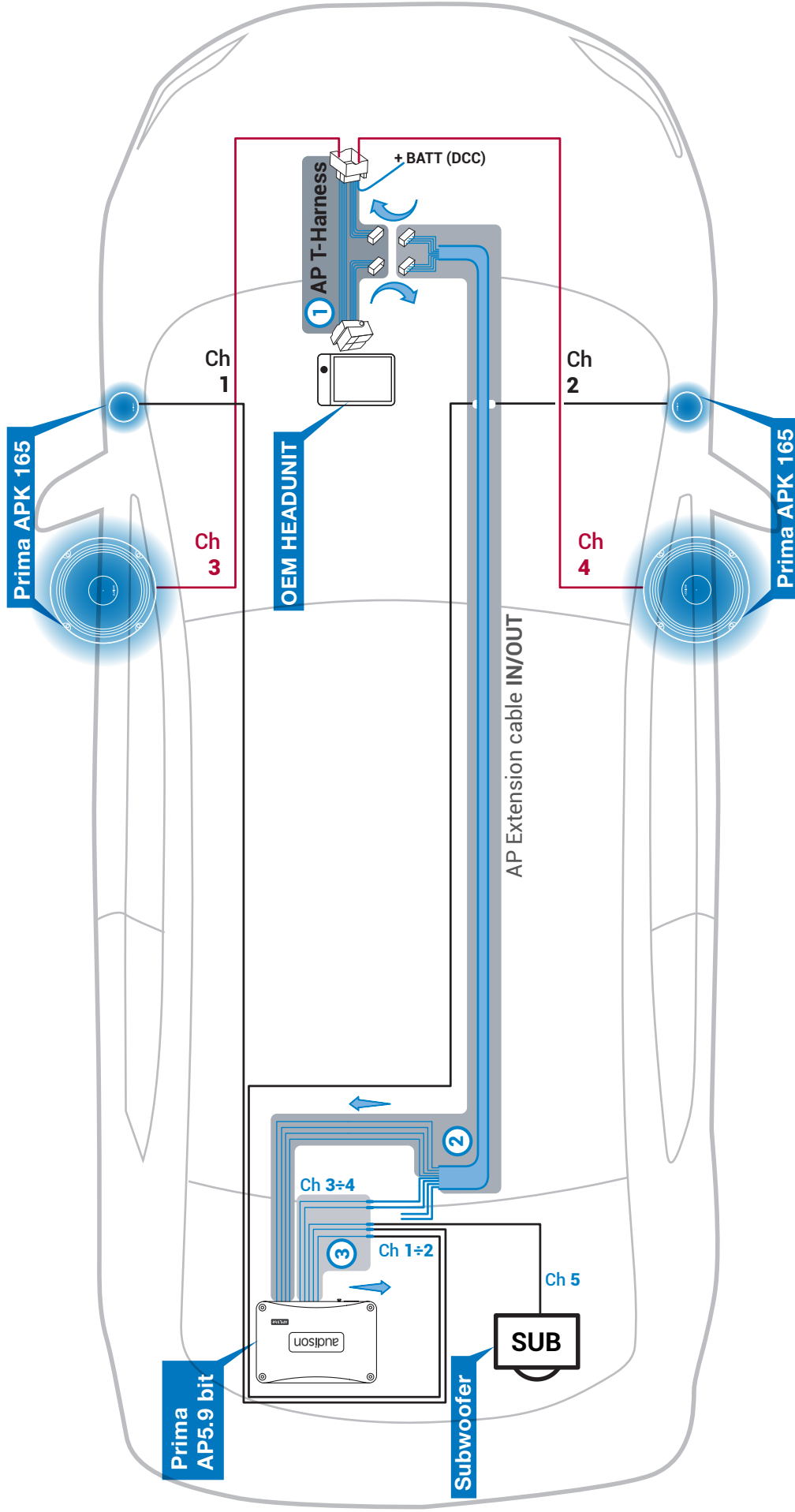

Legend

- █ AP Plug & Play cable
- █ OEM cable
- █ After market cable

All specifications subject to change without notice. 18A

POWER CHANNEL CONFIGURATION	
STEREO MODE	MONO
CH1 20 W @ 4 Ohm / 35 W @ 2 Ohm	CH3 50 W @ 4 Ohm / 85 W @ 2 Ohm
CH2 20 W @ 4 Ohm / 35 W @ 2 Ohm	CH4 50 W @ 4 Ohm / 85 W @ 2 Ohm
	CH5 140 W @ 4 Ohm / 280 W @ 2 Ohm

AP5.9 bit - Output configuration sheet - 2 way active Front + Sub

Detailed View

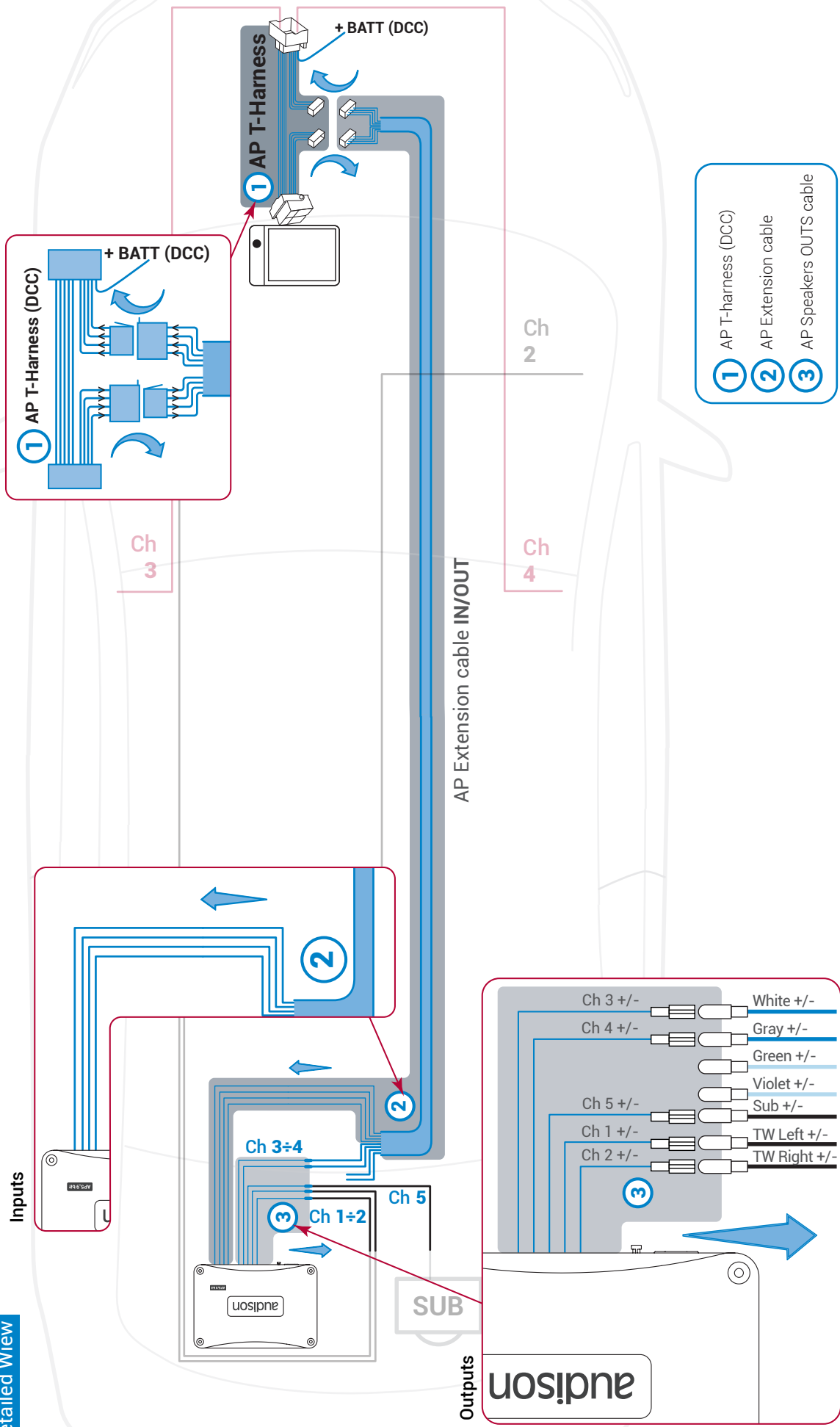

AP4.9 bit - Output configuration sheet - Front + Rear

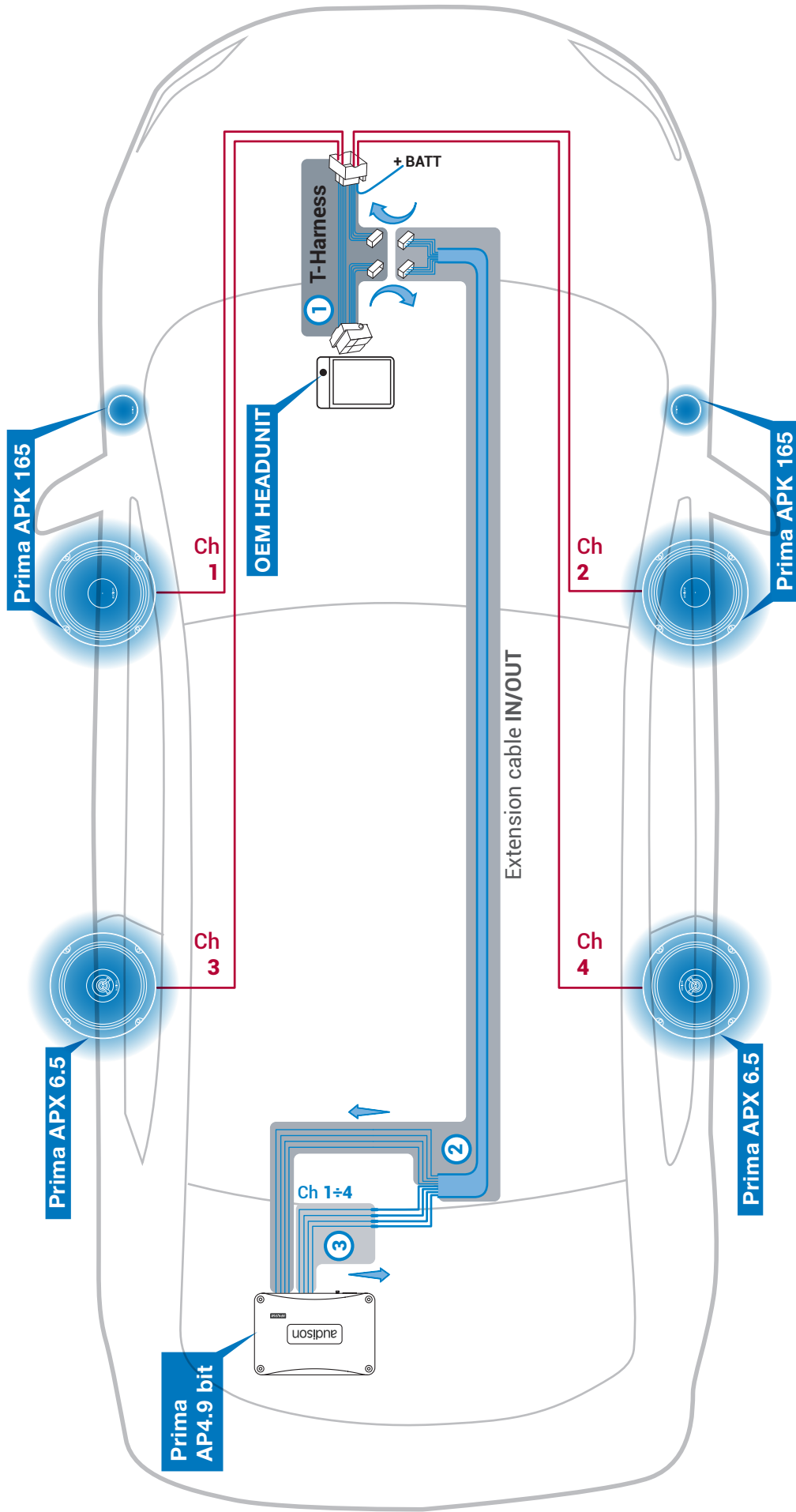

POWER CHANNEL CONFIGURATION	
STEREO MODE	
CH1	70 W @ 4 Ohm / 130 W @ 2 Ohm
CH3	70 W @ 4 Ohm / 130 W @ 2 Ohm
CH2	70 W @ 4 Ohm / 130 W @ 2 Ohm
CH4	70 W @ 4 Ohm / 130 W @ 2 Ohm

Legend

- █ AP Plug & Play cable
- █ OEM cable

All specifications subject to change without notice. 18A

AP4.9 bit - Output configuration sheet - Front + Rear

Detailed View

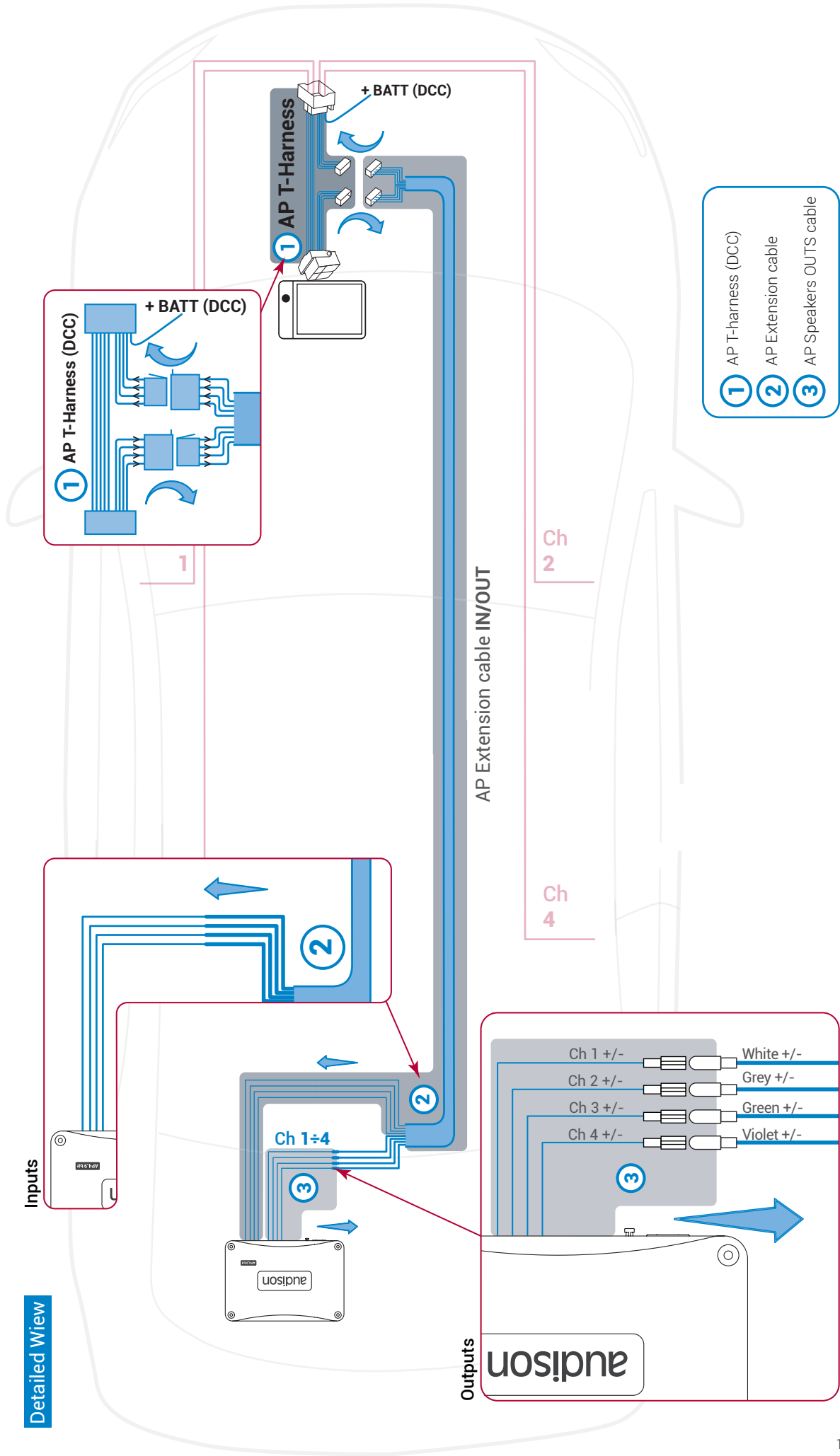

T-Harness compatibility list

Brand	Car Model	Chassis	From Year	To Year	Description	"ACC" Wire	AP T-HARNESS
Alfa Romeo	147		2000	2005	W/o OEM amplifier	Yes	AP T-H IS001
Alfa Romeo	147		2000	2005	With OEM Amplifier	Yes	AP T-H IS001
Alfa Romeo	147		2006	2010	W/o OEM amplifier	No	AP T-H IS001
Alfa Romeo	147		2006	2010	With OEM Amplifier	No	AP T-H IS001
Alfa Romeo	156		1996	2008	W/o OEM amplifier	Yes	AP T-H IS001
Alfa Romeo	156		1996	2008	With OEM Amplifier	Yes	AP T-H IS001
Alfa Romeo	156	Sportwagon	2000	2008	W/o OEM amplifier	Yes	AP T-H IS001
Alfa Romeo	156	Sportwagon	2000	2008	With OEM Amplifier	Yes	AP T-H IS001
Alfa Romeo	159		2005	2012	W/o OEM amplifier	No	AP T-H IS001
Alfa Romeo	159		2005	2012	With OEM Amplifier	No	AP T-H IS001
Alfa Romeo	159	Sportwagon	2006	2012	W/o OEM amplifier	No	AP T-H IS001
Alfa Romeo	159	Sportwagon	2006	2012	With OEM Amplifier	No	AP T-H IS001
Alfa Romeo	4C		2013	2018	W/o OEM amplifier	No	AP T-H FCA01
Alfa Romeo	4C	Spider	2014	2018	W/o OEM amplifier	No	AP T-H FCA01
Alfa Romeo	8C	Competizione	2007	2010	W/o OEM amplifier	No	AP T-H IS001
Alfa Romeo	Brera		2005	2010	W/o OEM amplifier	No	AP T-H IS001
Alfa Romeo	Brera		2005	2010	With OEM Amplifier	No	AP T-H IS001
Alfa Romeo	156	Crosswagon	2005	2008	W/o OEM amplifier	No	AP T-H IS001
Alfa Romeo	Giulietta		2010	2013	W/o OEM amplifier	No	AP T-H IS001
Alfa Romeo	Giulietta		2014	2018	W/o OEM amplifier	No	AP T-H FCA01
Alfa Romeo	GT	(937)	2004	2005	W/o OEM amplifier	Yes	AP T-H IS001
Alfa Romeo	GT	(937)	2004	2005	With OEM Amplifier	Yes	AP T-H IS001
Alfa Romeo	GT	(937)	2006	2010	W/o OEM amplifier	No	AP T-H IS001
Alfa Romeo	GT	(937)	2006	2010	With OEM Amplifier	No	AP T-H IS001
Alfa Romeo	Mito		2008	2013	W/o OEM amplifier	No	AP T-H IS001
Alfa Romeo	Mito		2014	2018	W/o OEM amplifier	No	AP T-H FCA01
Alfa Romeo	Mito		2014	2018	With OEM Amplifier	No	AP T-H FCA01
Aston Martin	DB 7		1998	2003	With OEM Amplifier (Full Bose)	No	AP T-H IS001
Aston Martin	V8 Vantage		1992	1999	With OEM Amplifier (Full Bose)	No	AP T-H IS001
Audi	A1		2010	2018	All Sound Systems w/o M.O.S.T. Amplifier.	No	AP T-H AVS02
Audi	A1	Sportback	2012	2018	W/o OEM amplifier	No	AP T-H AVS02
Audi	A2		1999	2005	Standard Sound System - No M.O.S.T. Ampli	No	AP T-H IS001
Audi	A2		1999	2005	Sub-Woofers & Rear System Amplified (Half Bose)	No	AP T-H IS001
Audi	A2		1999	2005	With Full Bose Sound System	No	AP T-H IS001
Audi	A2		2005	2005	Standard Sound System - No M.O.S.T. Ampli	No	AP T-H AVS01
Audi	A3	(8L)	1996	2003	Standard Sound System - No M.O.S.T. Ampli	Yes	AP T-H IS001
Audi	A3	(8L)	1996	2003	Sub-Woofers & Rear System Amplified (Half Bose)	Yes	AP T-H IS001

Brand	Car Model	Chassis	From Year	To Year	Description	"ACC" Wire	AP T-HARNESS
Audi	A3	(8L)	1996	2003	With Full Bose Sound System	Yes	AP T-H IS001
Audi	A3	Sedan, 3-Door, Sportback, Cabrio, S3, RS3 (8P/8PA)	2004	2012	Standard Sound System - No M.O.S.T. Ampli	No	AP T-H AVS01
Audi	A3	Sedan, 3-Door, Sportback, Cabrio, S3, RS3 (8P/8PA)	2004	2012	Sub-Woofers & Rear System Amplified (Half Bose)	No	AP T-H AVS01
Audi	A3	Sedan, 3-Door, Sportback, Cabrio, S3, RS3 (8P/8PA)	2004	2012	With Full Bose Sound System	No	AP T-H AVS01
Audi	A3	Sedan, Sportback, Cabrio, S3, RS3 (8V)	2013	2018	All Sound Systems w/o M.O.S.T. Amplifier.	No	AP T-H AVS02
Audi	A4	Sedan, Avant, Cabrio (B6/B7)	2004	2007	Standard Sound System - No M.O.S.T. Ampli	No	AP T-H AVS01
Audi	A4	Sedan, Avant, Cabrio (B6/B7)	2004	2007	Sub-Woofers & Rear System Amplified (Half Bose)	No	AP T-H AVS01
Audi	A4	Sedan, Avant, Cabrio (B6/B7)	2004	2007	With Full Bose Sound System	No	AP T-H AVS01
Audi	A4	Cabrio (B7)	2007	2009	MMI Basic - Standard Sound System - No M.O.S.T. Amplifier.	No	AP T-H AVS01
Audi	A4	Sedan, Avant (B8)	2008	2015	MMI Basic - Standard Sound System - No M.O.S.T. Amplifier.	No	AP T-H AVS01
Audi	A4	Sedan, Avant (B8)	2009	2015	MMI Navigation System, 8 Speakers w/o M.O.S.T. Amplifier	No	AP T-H AVS02
Audi	A4	Sedan, Avant (B8)	2009	2015	MMI Navigation System, 10 Speakers "Dsp" Sound System w/o M.O.S.T. Amplifier	No	AP T-H AVS02
Audi	A4	Allroad (B8)	2010	2015	MMI Basic - Standard Sound System - No M.O.S.T. Amplifier.	No	AP T-H AVS01
Audi	A4	Allroad (B8)	2010	2015	MMI Navigation System, 8 Speakers w/o M.O.S.T. Amplifier	No	AP T-H AVS02
Audi	A4	Allroad (B8)	2010	2015	MMI Navigation System, 10 Speakers "Dsp" Sound System w/o M.O.S.T. Amplifier	No	AP T-H AVS02
Audi	A4	Sedan, Avant (B9)	2016	2018	All Sound Systems w/o M.O.S.T. Amplifier.	No	AP T-H AVS02
Audi	A4	Allroad (B9)	2016	2018	All Sound Systems w/o M.O.S.T. Amplifier.	No	AP T-H AVS02
Audi	A5	Sportback (8TA), Coupè (8T3), Cabrio, S5, RS5	2007	2015	MMI Basic - Standard Sound System - No M.O.S.T. Amplifier.	No	AP T-H AVS01
Audi	A5	Sportback (8TA), Coupè (8T3), Cabrio, S5, RS5	2009	2015	MMI Navigation System, 8 SpeakeRS w/o M.O.S.T. Amplifier	No	AP T-H AVS02
Audi	A5	Sportback (8TA), Coupè (8T3), Cabrio, S5, RS5	2009	2015	MMI Navigation System, 10 SpeakeRS "Dsp" Sound System w/o M.O.S.T. Amplifier	No	AP T-H AVS02
Audi	A5	Sportback, Coupè (F5), Cabrio, S5, RS5	2016	2017	All Sound Systems w/o M.O.S.T. Amplifier.	No	AP T-H AVS02
Audi	A6	Sedan, Avant, S6, RS6 (C6)	2004	2008	All Sound Systems w/o M.O.S.T. Amplifier.	No	AP T-H AVS01
Audi	A6	All Road (C6)	2006	2008	MMI Basic - All Sound Systems w/o M.O.S.T. Amplifier.	No	AP T-H AVS01
Audi	A6	Sedan, Avant, S6, RS6 (C6)	2009	2018	MMI Navigation System, 8 SpeakeRS w/o M.O.S.T. Amplifier	No	AP T-H AVS02
Audi	A6	Sedan, Avant, S6, RS6 (C6)	2009	2018	MMI Navigation System, 10 SpeakeRS "Dsp" Sound System w/o M.O.S.T. Amplifier	No	AP T-H AVS02
Audi	A6	All Road (C6)	2009	2011	MMI Navigation System, 8 Speakers w/o M.O.S.T. Amplifier	No	AP T-H AVS02
Audi	A6	All Road (C6)	2009	2011	MMI Navigation System, 10 Speakers "Dsp" Sound System w/o M.O.S.T. Amplifier	No	AP T-H AVS02
Audi	A6	Allroad (C7)	2012	2018	All Sound Systems w/o M.O.S.T. Amplifier.	No	AP T-H AVS02
Audi	A7	Sportback, S7, RS7	2010	2018	All Sound Systems w/o M.O.S.T. Amplifier.	No	AP T-H AVS02
Audi	Q3	(8U)	2011	2018	All Sound Systems w/o M.O.S.T. Amplifier.	No	AP T-H AVS02
Audi	Q5	(B8)	2008	2016	MMI Basic - Standard Sound System - No M.O.S.T. Amplifier.	No	AP T-H AVS01
Audi	Q5	(B8)	2008	2016	MMI Navigation System, 8 Speakers w/o M.O.S.T. Amplifier	No	AP T-H AVS02

Brand	Car Model	Chassis	From Year	To Year	Description	"ACC" Wire	AP T-HARNESS
Audi	Q5	(B8)	2008	2016	MMI Navigation System, 10 Speakers "Dsp" Sound System w/o M.O.S.T. Amplifier	No	AP T-H AVS02
Audi	Q5	(B9)	2017	2018	All Sound Systems w/o M.O.S.T. Amplifier.	No	AP T-H AVS02
Audi	Q7	(4L)	2006	2015	MMI Basic - Standard Sound System - No M.O.S.T. Amplifier.	No	AP T-H AVS01
Audi	Q7	(4M)	2016	2018	All Sound Systems w/o M.O.S.T. Amplifier.	No	AP T-H AVS02
Audi	TT	Coupé, Roadster, RS (8N)	1998	2005	Vehicles With Iso Connector And Half/Full Amplified Systems	No	AP T-H ISO01
Audi	TT	Coupé, Roadster, RS (8J)	2006	2014	Chorus Radio	No	AP T-H AVS01
Audi	TT	Coupé, Roadster, RS (8J)	2006	2014	Sub-Woofer & Rear System Amplified (Half Bose)	No	AP T-H AVS01
Audi	TT	Coupé, Roadster, RS (8J)	2006	2014	With Full Bose Sound System	No	AP T-H AVS01
Audi	TT	Coupé, Roadster, RS (8S)	2014	2018	All Sound Systems w/o M.O.S.T. Amplifier.	No	AP T-H AVS02
Bentley	Arnage		1998	2008	W/o OEM amplifier	Yes	AP T-H ISO01
Bentley	Azure		1995	2003	W/o OEM amplifier	Yes	AP T-H ISO01
Bentley	Continental		1991	2003	W/o OEM amplifier	Yes	AP T-H ISO01
Bmw	1 Series	3-Door, Coupé, 5-Door, Cabrio (E81/E82/E87/E88)	2004	2011	"Base Audio" And "Hi-Fi" OEM Sound System - No M.O.S.T. Ampli	No	AP T-H BMW01
Bmw	1 Series	5-Door, 3-Door, Sedan (F20/21/F52)	2011	2018	"Base Audio" And "Hi-Fi" OEM Sound System - No M.O.S.T. Ampli	No	AP T-H BMW01
Bmw	2 Series	Coupé, Cabrio (F22/23)	2013	2018	"Base Audio" And "Hi-Fi" OEM Sound System - No M.O.S.T. Ampli	No	AP T-H BMW01
Bmw	2 Series	Active Tourer, Gran Tourer (F45/F46)	2014	2018	"Base Audio" And "Hi-Fi" OEM Sound System - No M.O.S.T. Ampli	No	AP T-H BMW01
Bmw	3 Series	(E46)	2001	2004	"Base Audio" And "Hi-Fi" OEM Sound System - No M.O.S.T. Ampli	Yes	AP T-H BMW01
Bmw	3 Series	Sedan, Touring, Coupé, Cabrio, M3 (E90/E91/E92/E93)	2005	2011	"Base Audio" And "Hi-Fi" OEM Sound System - No M.O.S.T. Ampli	No	AP T-H BMW01
Bmw	3 Series	Sedan, Touring, Limo (F30/F31)	2012	2018	"Base Audio" And "Hi-Fi" OEM Sound System - No M.O.S.T. Ampli	No	AP T-H BMW01
Bmw	3 Series	Coupé, Cabrio, Gran Coupé, M4, M4 Cabrio (F32/F33/F36/F82/F83)	2013	2018	"Base Audio" And "Hi-Fi" OEM Sound System - No M.O.S.T. Ampli	No	AP T-H BMW01
Bmw	5 Series	Sedan, Touring (E39)	2001	2003	"Base Audio" And "Hi-Fi" OEM Sound System - No M.O.S.T. Ampli	Yes	AP T-H BMW01
Bmw	5 Series	(E60/E61)	2004	2009	"Base Audio" And "Hi-Fi" OEM Sound System - No M.O.S.T. Ampli	No	AP T-H BMW01
Bmw	5 Series	GT, Sedan, Touring, Limo (F07/F10/F11/F18)	2010	2016	"Base Audio" And "Hi-Fi" OEM Sound System - No M.O.S.T. Ampli	No	AP T-H BMW01
Bmw	5 Series	Gran Coupé (F36)	2014	2018	"Base Audio" And "Hi-Fi" OEM Sound System - No M.O.S.T. Ampli	No	AP T-H BMW01
Bmw	5 Series	Sedan, Touring (G30, G31)	2017	2018	"Base Audio" And "Hi-Fi" OEM Sound System - No M.O.S.T. Ampli	No	AP T-H BMW01
Bmw	6 Series	(E63/E64)	2004	2010	"Base Audio" And "Hi-Fi" OEM Sound System - No M.O.S.T. Ampli	No	AP T-H BMW01
Bmw	6 Series	Gran Coupé, Cabrio, Coupé, Gran Coupé M, (F06/F12/F13/F14)	2011	2018	"Base Audio" And "Hi-Fi" OEM Sound System - No M.O.S.T. Ampli	No	AP T-H BMW01
Bmw	7 Series	Sedan, Limo (E65/E66)	2002	2008	"Base Audio" And "Hi-Fi" OEM Sound System - No M.O.S.T. Ampli	No	AP T-H BMW01
Bmw	7 Series	Sedan, Limo, Hybrid (F01/F02/F04)	2008	2015	"Base Audio" And "Hi-Fi" OEM Sound System - No M.O.S.T. Ampli	No	AP T-H BMW01
Bmw	7 Series	Sedan, Limo (G11/G12)	2016	2018	"Base Audio" And "Hi-Fi" OEM Sound System - No M.O.S.T. Ampli	No	AP T-H BMW01
Bmw	X1	(E84)	2010	2015	"Base Audio" And "Hi-Fi" OEM Sound System - No M.O.S.T. Ampli	No	AP T-H BMW01
Bmw	X1	Suv Limo (F48, F49)	2016	2018	"Base Audio" And "Hi-Fi" OEM Sound System - No M.O.S.T. Ampli	No	AP T-H BMW01

Brand	Car Model	Chassis	From Year	To Year	Description	"ACC" Wire	AP T-HARNESS
Bmw	X3	(E83)	2003	2010	"Base Audio" And "Hi-Fi" OEM Sound System - No M.O.S.T. Ampli	No	AP T-H BMW01
Bmw	X3	(F25)	2011	2017	"Base Audio" And "Hi-Fi" OEM Sound System - No M.O.S.T. Ampli	No	AP T-H BMW01
Bmw	X3	(G01)	2018	2018	"Base Audio" And "Hi-Fi" OEM Sound System - No M.O.S.T. Ampli	No	AP T-H BMW01
Bmw	X4	(F26)	2014	2018	"Base Audio" And "Hi-Fi" OEM Sound System - No M.O.S.T. Ampli	No	AP T-H BMW01
Bmw	X5	(E53)	2002	2006	"Base Audio" And "Hi-Fi" OEM Sound System - No M.O.S.T. Ampli	Yes	AP T-H BMW01
Bmw	X5	(E70)	2007	2013	"Base Audio" And "Hi-Fi" OEM Sound System - No M.O.S.T. Ampli	No	AP T-H BMW01
Bmw	X5	(F15/F85)	2014	2018	"Base Audio" And "Hi-Fi" OEM Sound System - No M.O.S.T. Ampli	No	AP T-H BMW01
Bmw	X6	(E71)	2008	2014	"Base Audio" And "Hi-Fi" OEM Sound System - No M.O.S.T. Ampli	No	AP T-H BMW01
Bmw	X6	Suv M (F16/F86)	2015	2018	"Base Audio" And "Hi-Fi" OEM Sound System - No M.O.S.T. Ampli	No	AP T-H BMW01
Bmw	Z4	(E85/E86)	2005	2008	"Base Audio" And "Hi-Fi" OEM Sound System - No M.O.S.T. Ampli	No	AP T-H BMW01
Bmw	Z4	(E89)	2009	2016	"Base Audio" And "Hi-Fi" OEM Sound System - No M.O.S.T. Ampli	No	AP T-H BMW01
Bmw	Z8	(E52)	1999	2003	"Base Audio" And "Hi-Fi" OEM Sound System - No M.O.S.T. Ampli	Yes	AP T-H BMW01
Cadillac	BLS		2006	2010	With Bose Sound System	No	AP T-H GMO01
Cadillac	CTS		2003	2007	With OEM Amplifier	No	AP T-H ISO01
Cadillac	CTS		2007	2014	With Bose Sound System	No	AP T-H GMN01
Cadillac	CTS		2007	2014	W/o Bose Sound System	No	AP T-H GMN01
Cadillac	Dts		2006	2011	With Bose Sound System	No	AP T-H GMO01
Cadillac	Escalade		2007	2011	W/o OEM amplifier	No	AP T-H GMO01
Cadillac	SRX		2004	2007	With OEM Amplifier	No	AP T-H ISO01
Cadillac	SRX		2007	2009	With Bose 8 Speaker Sound System	No	AP T-H GMO01
Cadillac	SRX		2010	2016	With OEM Amplifier	No	AP T-H GMN01
Cadillac	SRX		2010	2016	W/o OEM amplifier	No	AP T-H GMN01
Cadillac	STS		2005	2011	With OEM Amplifier	No	AP T-H ISO01
Chevrolet	Avalanche	(Us Model)	2007	2013	W/o OEM amplifier	No	AP T-H GMO01
Chevrolet	Aveo	(T200)	2008	2011	W/o OEM amplifier	Yes	AP T-H GMO01
Chevrolet	Aveo	(T300)	2012	2016	W/o OEM amplifier	No	AP T-H GMN01
Chevrolet	Camaro		2009	2016	W/o OEM amplifier	No	AP T-H GMN01
Chevrolet	Captiva		2006	2016	W/o OEM amplifier	No	AP T-H GMO01
Chevrolet	Cruze		2009	2015	W/o OEM amplifier	No	AP T-H GMN01
Chevrolet	Epica		2006	2015	W/o OEM amplifier	Yes	AP T-H GMO01
Chevrolet	Equinox	(Us Model)	2007	2018	W/o OEM amplifier	Yes	AP T-H GMO01
Chevrolet	Equinox	(Us Model)	2010	2018	W/o OEM amplifier	No	AP T-H GMN01
Chevrolet	Express	(Us Model)	2013	2016	With Navigation	Yes	AP T-H GMN01
Chevrolet	Express	(Us Model)	2013	2018	W/o OEM amplifier	Yes	AP T-H GMO01
Chevrolet	Genra		2007	2011	W/o OEM amplifier	Yes	AP T-H GMO01
Chevrolet	HHR		2006	2011	W/o OEM amplifier	Yes	AP T-H GMO01
Chevrolet	Impala	(Us Model)	2014	2016	W/o OEM amplifier	Yes	AP T-H GMO01

Brand	Car Model	Chassis	From Year	To Year	Description	"ACC" Wire	AP T-HARNESS
Chevrolet	Kalos		2007	2011	W/o OEM amplifier	Yes	AP T-H GM001
Chevrolet	Lacetti		2006	2011	W/o OEM amplifier	Yes	AP T-H GM001
Chevrolet	Malibu		2000	2007	W/o OEM amplifier	Yes	AP T-H GM001
Chevrolet	Malibu	(Us Model)	2012	2015	W/o OEM amplifier	No	AP T-H GMN01
Chevrolet	Montecarlo	(Us Model)	2000	2007	W/o OEM amplifier	Yes	AP T-H GM001
Chevrolet	Nubira		2006	2011	W/o OEM amplifier	Yes	AP T-H GM001
Chevrolet	Orlando		2011	2018	W/o OEM amplifier	No	AP T-H GMN01
Chevrolet	Silverado	1500/2500/3500	2007	2014	W/o OEM amplifier	Yes	AP T-H GM001
Chevrolet	Spark		2013	2018	W/o OEM amplifier	No	AP T-H GMN01
Chevrolet	Suburban		2007	2014	W/o OEM amplifier	No	AP T-H GM001
Chevrolet	Tacuma		2003	2008	W/o OEM amplifier	Yes	AP T-H IS001
Chevrolet	Tahoe		2007	2014	W/o OEM amplifier	Yes	AP T-H GM001
Chevrolet	Tosca		2006	2011	W/o OEM amplifier	Yes	AP T-H GM001
Chevrolet	Traverse	(Us Model)	2008	2018	W/o OEM amplifier	No	AP T-H GMN01
Chevrolet	Traverse		2008	2018	W/o OEM amplifier	Yes	AP T-H GM001
Chevrolet	Trax		2013	2017	W/o OEM amplifier	No	AP T-H GMN01
Chevrolet	Volt	(Us Model)	2011	2016	W/o OEM amplifier	No	AP T-H GMN01
Chevrolet	Winstorm		2006	2011	W/o OEM amplifier	Yes	AP T-H GM001
Chrysler	200		2011	2014	W/o Infinity Sound System	No	AP T-H CHR01
Chrysler	200	(C, Limited, S)	2015	2016	With A 5" Screen; w/o OEM Amplifier	No	AP T-H FCA01
Chrysler	200	(Lx)	2015	2016	With A 3.0" Screen; w/o OEM Amplifier	No	AP T-H FCA01
Chrysler	200		2017	2018	W/o OEM amplifier	No	AP T-H FCA01
Chrysler	300 / 300C		2008	2010	W/o Infinity Sound System	No	AP T-H CHR01
Chrysler	300 / 300C		2011	2018	Uconnect 8.4N/Rb5, 8.4/Re2 w/o OEM Amplifier	No	AP T-H CHR01
Chrysler	Aspen		2008	2009	W/o OEM amplifier	No	AP T-H CHR01
Chrysler	Grand Voyager		2008	2015	With And w/o OEM Amplifier. With Infinity Amplifier The OEM Hu Has Fixed Output Level.	No	AP T-H CHR01
Chrysler	Sebring		2007	2010	W/o OEM amplifier	No	AP T-H CHR01
Chrysler	Town & Country		2008	2016	With And w/o OEM Amplifier. With Infinity Amplifier The OEM Hu Has Fixed Output Level.	No	AP T-H CHR01
Chrysler	Voyager		2008	2018	With And w/o OEM Amplifier. With Infinity Amplifier The OEM Hu Has Fixed Output Level.	No	AP T-H CHR01
Citroen	C1		2005	2012	W/o OEM amplifier	Yes	AP T-H IS001
Citroen	C1		2014	2018	W/o OEM amplifier	No	AP T-H TOL01
Dacia	Duster		2010	2012	Ambiance And Laureate Vehicles w/o Media Nav Only	Yes	AP T-H IS001
Dacia	Logan		2007	2011	W/o OEM amplifier	Yes	AP T-H IS001
Dacia	Sandero		2008	2012	W/o OEM amplifier	Yes	AP T-H IS001
Dodge	Avenger		2007	2014	W/o OEM amplifier	No	AP T-H CHR01
Dodge	Caliber		2009	2012	W/o OEM amplifier	No	AP T-H CHR01
Dodge	Caravan		2009	2016	W/o OEM amplifier	No	AP T-H CHR01

Brand	Car Model	Chassis	From Year	To Year	Description	"ACC" Wire	AP T-HARNESS
Dodge	Challenger		2008	2014	W/o OEM amplifier	No	AP T-H CHR01
Dodge	Charger		2008	2010	W/o OEM amplifier	No	AP T-H CHR01
Dodge	Dakota		2008	2011	W/o OEM amplifier	No	AP T-H CHR01
Dodge	Dart		2013	2014	With 8.4-Inch Lcd Display; w/o OEM Amplifier	No	AP T-H FCA01
Dodge	Dart		2013	2016	W/o 8.4-Inch Lcd Display And W/O OEM Amplifier	No	AP T-H FCA01
Dodge	Durango		2008	2013	W/o OEM amplifier	No	AP T-H CHR01
Dodge	Durango		2014	2016	W/o OEM amplifier	No	AP T-H FCA01
Dodge	Grand Caravan		2008	2018	W/o OEM amplifier	No	AP T-H CHR01
Dodge	Journey		2009	2010	W/o OEM amplifier	No	AP T-H CHR01
Dodge	Magnum		2008	2009	W/o OEM amplifier	No	AP T-H CHR01
Dodge	Nitro		2007	2011	W/o OEM amplifier	No	AP T-H CHR01
Dodge	Ram	1500	2009	2011	W/o OEM amplifier	No	AP T-H CHR01
Dodge	Ram	2500/3500	2010	2011	W/o OEM amplifier	No	AP T-H CHR01
Dodge	Ram	4500/5500 Chassis Cab	2011	2012	W/o OEM amplifier	No	AP T-H CHR01
Dodge	Ram	(1500, 2500, 3500)	2013	2018	W/o OEM amplifier	No	AP T-H FCA01
Dodge	Ram	Chassis Cab	2013	2018	W/o OEM amplifier	No	AP T-H FCA01
Dodge	Ram		2013	2016	W/o OEM amplifier	No	AP T-H FCA01
Dodge	Ram	Promaster	2014	2018	W/o OEM amplifier	No	AP T-H FCA01
Dodge	Ram	Promaster City	2015	2018	W/o OEM amplifier	No	AP T-H FCA01
Dodge	Viper		2014	2018	W/o OEM amplifier	No	AP T-H FCA01
Ferrari	360		1999	2005	With And w/o OEM Amplifier	Yes	AP T-H ISO01
Ferrari	458		2010	2015	W/o OEM amplifier	No	AP T-H CHR01
Ferrari	458		2010	2015	With OEM Amplifier (Less Than 8Ch)	No	AP T-H CHR01
Ferrari	488		2016	2018	W/o OEM amplifier	No	AP T-H CHR01
Ferrari	488		2016	2018	With OEM Amplifier (Less Than 8Ch)	No	AP T-H CHR01
Ferrari	599		2006	2012	W/o OEM amplifier	Yes	AP T-H ISO01
Ferrari	599		2006	2012	With OEM Amplifier	Yes	AP T-H ISO01
Ferrari	612 Scaglietti		2004	2011	W/o OEM amplifier	Yes	AP T-H ISO01
Ferrari	California		2008	2014	W/o OEM amplifier	No	AP T-H CHR01
Ferrari	California		2008	2014	With OEM Amplifier (Less Than 8Ch)	No	AP T-H CHR01
Ferrari	California T		2015	2017	W/o OEM amplifier	No	AP T-H FCA01
Ferrari	California T		2015	2017	With OEM Amplifier (Less Than 8Ch)	No	AP T-H FCA01
Ferrari	F430		2004	2009	With And w/o OEM Amplifier	Yes	AP T-H ISO01
Ferrari	FF		2011	2016	W/o OEM amplifier	No	AP T-H CHR01
Ferrari	FF		2011	2016	With OEM Amplifier (8Ch Only)	No	AP T-H CHR01
Fiat	500		2007	2014	W/o OEM amplifier	No	AP T-H ISO01
Fiat	500		2015	2018	W/o OEM amplifier	No	AP T-H FCA01
Fiat	500L		2013	2018	W/o OEM amplifier	No	AP T-H FCA01
Fiat	500X		2014	2018	W/o OEM amplifier	No	AP T-H FCA01

Brand	Car Model	Chassis	From Year	To Year	Description	"ACC" Wire	AP T-HARNESS
Fiat	Albea		2002	2012	W/o OEM amplifier	Yes	AP T-H IS001
Fiat	Bravo		2007	2014	W/o OEM amplifier	Yes	AP T-H IS001
Fiat	Doblo'		2010	2015	W/o OEM amplifier	Yes	AP T-H IS001
Fiat	Doblo'		2015	2018	W/o OEM amplifier	No	AP T-H FCA01
Fiat	Freemont		2011	2018	W/o OEM amplifier	No	AP T-H CHR01
Fiat	Grande Punto		2005	2012	W/o OEM amplifier	Yes	AP T-H IS001
Fiat	Idea		2004	2012	W/o OEM amplifier	Yes	AP T-H IS001
Fiat	Linea		2007	2014	W/o OEM amplifier	Yes	AP T-H IS001
Fiat	Panda		2004	2011	W/o OEM amplifier	Yes	AP T-H IS001
Fiat	Panda		2012	2018	W/o OEM amplifier	No	AP T-H IS001
Fiat	Punto Evo		2012	2018	W/o OEM amplifier	No	AP T-H IS001
Fiat	Qubo		2009	2018	W/o OEM amplifier	Yes	AP T-H IS001
Fiat	Stilo		2001	2008	W/o OEM amplifier	Yes	AP T-H IS001
Fiat	Tipo		2016	2018	W/o OEM amplifier	No	AP T-H FCA01
Ford	Crown Victoria		2003	2011	W/o OEM amplifier	Yes	AP T-H FRD01
Ford	Econoline		2009	2018	W/o OEM amplifier	Yes	AP T-H FRD01
Ford	Edge		2007	2010	W/o OEM amplifier	Yes	AP T-H FRD01
Ford	Escape		2009	2012	W/o OEM amplifier	Yes	AP T-H FRD01
Ford	Expedition	Fleet	2015	2015	W/o OEM amplifier	Yes	AP T-H FRD01
Ford	Expedition	Ssv	2015	2015	W/o OEM amplifier	Yes	AP T-H FRD01
Ford	Expedition		2003	2014	W/o OEM amplifier	Yes	AP T-H FRD01
Ford	Explorer		2006	2010	W/o OEM amplifier	Yes	AP T-H FRD01
Ford	Explorer	Sport Trac	2006	2010	W/o OEM amplifier	Yes	AP T-H FRD01
Ford	F-250/350/450/550		2004	2014	W/o OEM amplifier	Yes	AP T-H FRD01
Ford	F-650/750		2011	2018	W/o OEM amplifier	Yes	AP T-H FRD01
Ford	Five Hundred		2005	2007	W/o OEM amplifier	Yes	AP T-H FRD01
Ford	Five Hundred		2005	2007	W/o OEM amplifier	Yes	AP T-H FRD01
Ford	Flex		2008	2012	W/o OEM amplifier	Yes	AP T-H FRD01
Ford	Focus		2005	2011	W/o OEM amplifier	Yes	AP T-H FRD01
Ford	Freestar		2004	2007	W/o OEM amplifier	Yes	AP T-H FRD01
Ford	Freestyle		2005	2007	W/o OEM amplifier	Yes	AP T-H FRD01
Ford	Fusion		2006	2012	W/o OEM amplifier	Yes	AP T-H FRD01
Ford	Mustang		2004	2014	W/o OEM amplifier	Yes	AP T-H FRD01
Ford	Taurus		2010	2012	W/o OEM amplifier	Yes	AP T-H FRD01
Ford	Taurus / Taurus X		2008	2009	W/o OEM amplifier	Yes	AP T-H FRD01
Ford	Thunderbird		2004	2005	W/o OEM amplifier	Yes	AP T-H FRD01
Ford	Transit	Connect	2012	2013	W/o OEM amplifier	Yes	AP T-H FRD01
GMC	Acadia		2007	2018	W/o OEM amplifier	Yes	AP T-H GMO01
GMC	Savana	Full Size Van	2008	2018	W/o OEM amplifier	Yes	AP T-H GMO01
GMC	Savana		2013	2015	W/o OEM Amplifier and with Navigation	No	AP T-H GMN01

Brand	Car Model	Chassis	From Year	To Year	Description	"ACC" Wire	AP T-HARNESS
GMC	Sierra		2007	2013	W/o OEM amplifier	Yes	AP T-H GMO01
GMC	Sierra	2500Hd, 3500Hd	2014	2014	W/o Navigation and w/o Amplifier	Yes	AP T-H GMO01
GMC	Sierra	2500Hd, 3500Hd	2014	2014	With Navigation And w/o Amplifier	No	AP T-H GMN01
GMC	Terrain		2009	2017	W/o OEM amplifier	No	AP T-H GMN01
GMC	Terrain		2010	2018	W/o OEM amplifier	Yes	AP T-H GMO01
GMC	Yukon		2007	2014	With Navigation And w/o Amplifier	No	AP T-H GMN01
GMC	Yukon		2012	2014	W/o OEM amplifier	Yes	AP T-H GMO01
Honda	Accord		2008	2018	W/o OEM amplifier	Yes	AP T-H HON01
Honda	Ballade		2011	2018	W/o OEM amplifier	Yes	AP T-H HON01
Honda	City		2008	2018	W/o OEM amplifier	Yes	AP T-H HON01
Honda	Civic		2012	2018	W/o OEM amplifier	Yes	AP T-H HON01
Honda	CR-V		2009	2018	W/o OEM amplifier	Yes	AP T-H HON01
Honda	CR-Z		2010	2016	W/o OEM amplifier	Yes	AP T-H HON01
Honda	Fit		2008	2018	W/o OEM amplifier	Yes	AP T-H HON01
Honda	Fit	Aria	2008	2016	W/o OEM amplifier	Yes	AP T-H HON01
Honda	HR-V		2016	2018	No Basic Head Unit. w/o OEM Amplifier	Yes	AP T-H HON01
Honda	Insight		2009	2015	W/o OEM amplifier	Yes	AP T-H HON01
Honda	Jazz		2015	2018	No Basic Head Unit. w/o OEM Amplifier	Yes	AP T-H HON01
Honda	MR-V		2008	2018	W/o OEM amplifier	Yes	AP T-H HON01
Honda	Odyssey		2008	2018	W/o OEM amplifier	Yes	AP T-H HON01
Honda	Pilot		2008	2018	W/o OEM amplifier	Yes	AP T-H HON01
Honda	Ridgeline		2009	2018	W/o OEM amplifier	Yes	AP T-H HON01
Hummer	H-3		2005	2010	With Bose Amplifier	No	AP T-H ISO01
Hyundai	Sonata	(Us Model)	2006	2008	W/o OEM amplifier	Yes	AP T-H FRD01
Infiniti	G 35		2008	2016	W/o OEM amplifier	Yes	AP T-H INI01
Infiniti	G 37		2008	2016	W/o OEM amplifier	Yes	AP T-H INI01
Jeep	Cherokee		2008	2013	W/o OEM amplifier	No	AP T-H CHR01
Jeep	Cherokee	(All Trims Less Sport)	2014	2018	W/o OEM amplifier	No	AP T-H FCA01
Jeep	Cherokee	(Sport)	2014	2018	W/o OEM amplifier	No	AP T-H FCA01
Jeep	Commander		2008	2010	W/o OEM amplifier	No	AP T-H CHR01
Jeep	Compass		2009	2018	W/o OEM amplifier	No	AP T-H CHR01
Jeep	Grand Cherokee		2008	2010	W/o OEM amplifier	No	AP T-H CHR01
Jeep	Grand Cherokee		2014	2018	W/o OEM amplifier	No	AP T-H FCA01
Jeep	Liberty		2008	2012	W/o OEM amplifier	No	AP T-H CHR01
Jeep	Patriot		2009	2018	W/o OEM amplifier	No	AP T-H CHR01
Jeep	Renegade		2014	2018	W/o OEM amplifier	No	AP T-H FCA01
Jeep	Wrangler		2007	2018	W/o OEM amplifier	No	AP T-H CHR01
Jeep	Wrangler	Unlimited	2007	2018	W/o OEM amplifier	No	AP T-H CHR01
Lamborghini	Aventador		2011	2018	W/o OEM amplifier	No	AP T-H AVS01
Lamborghini	Gallardo		2003	2013	W/o OEM amplifier	No	AP T-H AVS01

Brand	Car Model	Chassis	From Year	To Year	Description	"ACC" Wire	AP T-HARNESS
Lamborghini	Huracan		2014	2018	W/o OEM amplifier	No	AP T-H AVS01
Lamborghini	Murcielago		2001	2010	W/o OEM amplifier	No	AP T-H IS001
Lancia	Thema		2011	2018	Uconnect 8.4N/Rb5, 8.4/Re2; w/o OEM Amplifier	No	AP T-H CHR01
Lancia	Voyager		2011	2015	W/o OEM amplifier	No	AP T-H CHR01
Lancia	Ypsilon		2003	2018	W/o OEM amplifier	No	AP T-H IS001
Land Rover	Discovery	4Th Series	2010	2016	W/o OEM amplifier	Yes	AP T-H FRD01
Land Rover	Discovery	2Nd Series	1999	2004	W/o OEM amplifier	No	AP T-H IS001
Land Rover	Evoque		2011	2018	W/o OEM amplifier	Yes	AP T-H FRD01
Land Rover	Freelander	1St Series	2003	2006	W/o OEM amplifier	Yes	AP T-H FRD01
Land Rover	Freelander	2Nd Series	2013	2014	W/o OEM amplifier	Yes	AP T-H FRD01
Land Rover	Range Rover		1999	2002	W/o OEM amplifier	No	AP T-H IS001
Lexus	Ct200H		2011	2014	W/o OEM amplifier	Yes	AP T-H TOL01
Lexus	Gx 470		2002	2014	W/o OEM amplifier	Yes	AP T-H TOL01
Lexus	IS 200		1999	2005	W/o OEM amplifier	Yes	AP T-H TOL01
Lexus	IS 300		2001	2005	W/o OEM amplifier	Yes	AP T-H TOL01
Lincoln	LS Series		2003	2006	W/o OEM amplifier	Yes	AP T-H FRD01
Lincoln	MKX		2007	2010	W/o OEM amplifier	Yes	AP T-H FRD01
Lincoln	MKZ		2007	2009	W/o OEM amplifier	Yes	AP T-H FRD01
Lincoln	Navigator		2003	2007	W/o OEM amplifier	Yes	AP T-H FRD01
Lincoln	Town Car		2003	2011	W/o OEM amplifier	Yes	AP T-H FRD01
Lincoln	Zephyr		2006	2006	W/o OEM amplifier	Yes	AP T-H FRD01
Maserati	222		1992	1994	W/o OEM amplifier	Yes	AP T-H IS001
Maserati	430		1992	1994	W/o OEM amplifier	Yes	AP T-H IS001
Maserati	3200 GT		1998	2002	W/o OEM amplifier	Yes	AP T-H IS001
Maserati	4200 GT		2002	2007	W/o OEM amplifier	Yes	AP T-H IS001
Maserati	Coupe		2002	2007	W/o OEM amplifier	Yes	AP T-H IS001
Maserati	Ghibli		1993	1999	W/o OEM amplifier	Yes	AP T-H IS001
Maserati	Ghibli		2013	2017	W/o OEM amplifier	No	AP T-H CHR01
Maserati	Grancabrio		2010	2018	W/o OEM amplifier	No	AP T-H AVS01
Maserati	Gransport		2004	2007	W/o OEM amplifier	Yes	AP T-H IS001
Maserati	Granturismo		2007	2018	W/o OEM amplifier	No	AP T-H AVS01
Maserati	Levante		2016	2018	W/o OEM amplifier	No	AP T-H CHR01
Maserati	Quattroporte		1994	2003	W/o OEM amplifier	Yes	AP T-H IS001
Maserati	Quattroporte	(M139)	2004	2014	W/o OEM amplifier	No	AP T-H AVS01
Maserati	Quattroporte	(M156)	2014	2018	W/o OEM amplifier	No	AP T-H CHR01
Maserati	Shamal		1992	1997	W/o OEM amplifier	Yes	AP T-H IS001
Maserati	Spyder		2002	2007	W/o OEM amplifier	Yes	AP T-H IS001
Mazda	2		2003	2018	W/o OEM amplifier	Yes	AP T-H MAZ01
Mazda	3		2003	2018	W/o OEM amplifier	Yes	AP T-H MAZ01

Brand	Car Model	Chassis	From Year	To Year	Description	"ACC" Wire	AP T-HARNESS
Mazda	5		2005	2018	W/o OEM amplifier	Yes	AP T-H MAZ01
Mazda	6		2008	2018	W/o OEM amplifier	Yes	AP T-H MAZ01
Mazda	323		2001	2002	W/o OEM amplifier	Yes	AP T-H MAZ01
Mazda	626		1997	2002	W/o OEM amplifier	Yes	AP T-H MAZ01
Mazda	Biante		2008	2018	W/o OEM amplifier	Yes	AP T-H MAZ01
Mazda	Bt50		2006	2012	W/o OEM amplifier	Yes	AP T-H MAZ01
Mazda	CX-3		2015	2018	W/o OEM amplifier	Yes	AP T-H MAZ01
Mazda	CX-5		2012	2018	W/o OEM amplifier	Yes	AP T-H MAZ01
Mazda	CX-7		2006	2012	W/o OEM amplifier	Yes	AP T-H MAZ01
Mazda	CX-9		2007	2018	W/o OEM amplifier	Yes	AP T-H MAZ01
Mazda	Demio		1996	2002	W/o OEM amplifier	Yes	AP T-H MAZ01
Mazda	Miata		2001	2018	W/o OEM amplifier	Yes	AP T-H MAZ01
Mazda	Millenia		2001	2003	W/o OEM amplifier	Yes	AP T-H MAZ01
Mazda	MPV		2001	2007	W/o OEM amplifier	Yes	AP T-H MAZ01
Mazda	MX5		2001	2018	W/o OEM amplifier	Yes	AP T-H MAZ01
Mazda	Premazy		2001	2018	W/o OEM amplifier	Yes	AP T-H MAZ01
Mazda	Protégé		2001	2005	W/o OEM amplifier	Yes	AP T-H MAZ01
Mazda	RX-8		2003	2011	W/o OEM amplifier	Yes	AP T-H MAZ01
Mazda	Tribute		2001	2008	W/o OEM amplifier	Yes	AP T-H MAZ01
Mazda	Tribute		2008	2011	W/o OEM amplifier	Yes	AP T-H FRD01
Mercedes	A Class	(W169)	2004	2011	W/o OEM amplifier	No	AP T-H ISO01
Mercedes	A Class	(W169)	2004	2011	W/o OEM amplifier	No	AP T-H MBP01
Mercedes	A Class	(W176)	2012	2018	W/o OEM amplifier	No	AP T-H MBP01
Mercedes	B Class	(W245)	2004	2011	W/o OEM amplifier	No	AP T-H MBP01
Mercedes	B Class	(W246)	2012	2018	W/o OEM amplifier	No	AP T-H MBP01
Mercedes	C Class	(W203)	2000	2003	W/o OEM amplifier	No	AP T-H ISO01
Mercedes	C Class	(W203)	2004	2008	W/o OEM amplifier	No	AP T-H MBP01
Mercedes	C Class	(W204)	2009	2014	W/o OEM amplifier	No	AP T-H MBP01
Mercedes	C Class	(W205)	2014	2018	W/o OEM amplifier	No	AP T-H MBP01
Mercedes	CL Class		2008	2014	W/o OEM amplifier	No	AP T-H MBP01
Mercedes	CLA Class	(C117)	2013	2018	W/o OEM amplifier	No	AP T-H MBP01
Mercedes	CLA Class		2015	2017	W/o OEM amplifier	No	AP T-H MBP01
Mercedes	CLC Class		2008	2014	W/o OEM amplifier	No	AP T-H MBP01
Mercedes	CLK Class	(W209)	2002	2005	W/o OEM amplifier	No	AP T-H ISO01
Mercedes	CLK Class	(W209)	2004	2010	W/o OEM amplifier	No	AP T-H MBP01
Mercedes	CLS Class	(W219)	2005	2010	W/o OEM amplifier	No	AP T-H MBP01
Mercedes	CLS Class	(W218)	2011	2018	W/o OEM amplifier	No	AP T-H MBP01
Mercedes	E Class	(W212)	2009	2016	W/o OEM amplifier	No	AP T-H MBP01
Mercedes	E Class	Coupé (C207)	2010	2018	W/o OEM amplifier	No	AP T-H MBP01
Mercedes	E Class	(W213)	2016	2017	W/o OEM amplifier	No	AP T-H MBP01

Brand	Car Model	Chassis	From Year	To Year	Description	"ACC" Wire	AP T-HARNESS
Mercedes	G Class	(W463)	2007	2014	W/o OEM amplifier	No	AP T-H MBP01
Mercedes	GL Class	(X164)	2006	2011	W/o OEM amplifier	No	AP T-H MBP01
Mercedes	GL Class	(X166)	2012	2017	W/o OEM amplifier	No	AP T-H MBP01
Mercedes	GLA Class	(X156)	2013	2018	W/o OEM amplifier	No	AP T-H MBP01
Mercedes	GLC Class	(Glc)	2016	2018	W/o OEM amplifier	No	AP T-H MBP01
Mercedes	GLK Class	(X204)	2008	2015	W/o OEM amplifier	No	AP T-H MBP01
Mercedes	ML Class	(W164)	2006	2014	W/o OEM amplifier	No	AP T-H MBP01
Mercedes	R Class	(W251)	2006	2014	W/o OEM amplifier	No	AP T-H MBP01
Mercedes	S Class	(W221)	2004	2013	W/o OEM amplifier	No	AP T-H MBP01
Mercedes	SL Class	(R230)	2001	2011	W/o OEM amplifier	No	AP T-H MBP01
Mercedes	SL Class	(R231)	2012	2014	W/o OEM amplifier	No	AP T-H MBP01
Mercedes	SLC Class		2016	2018	W/o OEM amplifier	No	AP T-H MBP01
Mercedes	SLK Class	(R171)	2004	2011	W/o OEM amplifier	No	AP T-H MBP01
Mercedes	SLK Class	(R172)	2012	2015	W/o OEM amplifier	No	AP T-H MBP01
Mercedes	Sprinter		2006	2014	W/o OEM amplifier	No	AP T-H ISO01
Mercedes	Vaneo	(W414)	2002	2004	W/o OEM amplifier	Yes	AP T-H ISO01
Mercedes	Viano	(W639)	2003	2014	With "Audio10" Head Unit W/o OEM amplifier	No	AP T-H ISO01
Mercedes	Viano	(W639)	2006	2014	With "Audio20" or "NTG" Head Unit W/o OEM amplifier	No	AP T-H MBP01
Mercedes	Vito	(W639)	2003	2014	With "Audio20" or "NTG" Head Unit W/o OEM amplifier	No	AP T-H MBP01
Mercedes	Vito	(W639)	2003	2014	With "Audio10" Head Unit W/o OEM amplifier	No	AP T-H ISO01
Mercedes	Viano	(W447)	2015	2018	W/o OEM amplifier	No	AP T-H MBP01
Mercedes	Vito	(W447)	2015	2018	W/o OEM amplifier	No	AP T-H MBP01
Mercury	Grand Marquis		2003	2010	W/o OEM amplifier	Yes	AP T-H FRD01
Mercury	Marauder		2003	2004	W/o OEM amplifier	Yes	AP T-H FRD01
Mercury	Mariner		2005	2011	W/o OEM amplifier	Yes	AP T-H FRD01
Mercury	Milan		2006	2011	W/o OEM amplifier	Yes	AP T-H FRD01
Mercury	Montego		2005	2007	W/o OEM amplifier	Yes	AP T-H FRD01
Mercury	Monterey		2004	2007	W/o OEM amplifier	Yes	AP T-H FRD01
Mercury	Mountaineer		2004	2010	W/o OEM amplifier	Yes	AP T-H FRD01
Mercury	Sable		2008	2009	W/o OEM amplifier	Yes	AP T-H FRD01
Mini	3-Door Hatch	(R56)	2006	2013	W/o OEM amplifier	No	AP T-H BMW01
Mini	3-Door Hatch	(F56)	2014	2018	W/o OEM amplifier	No	AP T-H BMW01
Mini	5-Door Hatch	(F55)	2014	2018	W/o OEM amplifier	No	AP T-H BMW01
Mini	Cabrio	(R57)	2008	2014	W/o OEM amplifier	No	AP T-H BMW01
Mini	Cabrio	(F57)	2015	2018	W/o OEM amplifier	No	AP T-H BMW01
Mini	Clubman	(R55)	2006	2014	W/o OEM amplifier	No	AP T-H BMW01
Mini	Clubman	(F54)	2015	2018	W/o OEM amplifier	No	AP T-H BMW01
Mini	Countryman	(R60)	2010	2016	W/o OEM amplifier	No	AP T-H BMW01
Mini	Countryman	(F60)	2017	2018	W/o OEM amplifier	No	AP T-H BMW01

Brand	Car Model	Chassis	From Year	To Year	Description	"ACC" Wire	AP T-HARNESS
Mini	Coupé	(R58)	2011	2015	W/o OEM amplifier	No	AP T-H BMW01
Mini	Paceman	(R61)	2012	2016	W/o OEM amplifier	No	AP T-H BMW01
Mini	Roadster	(R59)	2011	2015	W/o OEM amplifier	No	AP T-H BMW01
Mitsubishi	Raider		2008	2009	W/o OEM amplifier	No	AP T-H CHR01
Nissan	350Z		2004	2009	W/o OEM amplifier	Yes	AP T-H ISO01
Nissan	370Z		2008	2018	W/o OEM amplifier	No	AP T-H INI01
Nissan	Juke		2010	2018	W/o OEM amplifier	Yes	AP T-H INI01
Nissan	Leaf		2010	2018	W/o OEM amplifier	Yes	AP T-H INI01
Nissan	Maxima		2009	2014	W/o OEM amplifier	No	AP T-H INI01
Nissan	Micra		2008	2018	W/o OEM amplifier	Si	AP T-H INI01
Nissan	Murano		2008	2014	W/o OEM amplifier	No	AP T-H INI01
Nissan	Note		2008	2018	W/o OEM amplifier	Si	AP T-H INI01
Nissan	NV200		2011	2018	W/o OEM amplifier	Si	AP T-H INI01
Nissan	NV300		2014	2018	W/o OEM amplifier	Si	AP T-H INI01
Nissan	NV400		2011	2018	W/o OEM amplifier	Si	AP T-H INI01
Nissan	Pathfinder		2007	2014	W/o OEM amplifier	Si	AP T-H INI01
Nissan	Pulsar		2015	2018	W/o OEM amplifier	Si	AP T-H INI01
Nissan	X-Trail		2007	2018	W/o OEM amplifier	Si	AP T-H INI01
Opel	Adam		2013	2018	W/o OEM amplifier	No	AP T-H GMN01
Opel	Agila		2005	2007	W/o OEM amplifier	No	AP T-H AVS01
Opel	Ampera		2011	2018	W/o OEM amplifier	No	AP T-H GMN01
Opel	Antara		2006	2015	W/o OEM amplifier	No	AP T-H AVS01
Opel	Astra		2004	2008	W/o OEM amplifier	No	AP T-H AVS01
Opel	Astra	GTC (H)	2005	2011	W/o OEM amplifier	No	AP T-H AVS01
Opel	Astra	J	2010	2015	W/o OEM amplifier	No	AP T-H GMN01
Opel	Astra	GTC (J)	2011	2017	W/o OEM amplifier	No	AP T-H GMN01
Opel	Astra	K	2016	2018	W/o OEM amplifier	No	AP T-H GMN01
Opel	Combo		2004	2012	W/o OEM amplifier	No	AP T-H AVS01
Opel	Combo	X12	2012	2015	W/o OEM amplifier	No	AP T-H ISO01
Opel	Combo		2015	2018	W/o OEM amplifier	No	AP T-H GMN01
Opel	Corsa		2006	2014	W/o OEM amplifier	No	AP T-H AVS01
Opel	Corsa		2015	2018	W/o OEM amplifier	No	AP T-H GMN01
Opel	GT Roadster		2007	2010	W/o OEM amplifier	Yes	AP T-H GMO01
Opel	GT Roadster		2007	2010	W/o OEM amplifier	No	AP T-H AVS01
Opel	Insignia		2008	2013	W/o OEM amplifier	No	AP T-H GMN01
Opel	Meriva	A	2002	2005	W/o OEM amplifier	No	AP T-H ISO01
Opel	Meriva	A	2005	2009	W/o OEM amplifier	No	AP T-H AVS01
Opel	Meriva	B	2010	2018	W/o OEM amplifier	No	AP T-H GMN01
Opel	Mokka/Mokka X		2012	2018	W/o OEM amplifier	No	AP T-H GMN01
Opel	Movano		2006	2013	W/o OEM amplifier	No	AP T-H AVS01

Brand	Car Model	Chassis	From Year	To Year	Description	"ACC" Wire	AP T-HARNESS
Opel	Signum		2003	2008	W/o OEM amplifier	No	AP T-H AVS01
Opel	Tigra	Twintop	2005	2009	W/o OEM amplifier	No	AP T-H AVS01
Opel	Vectra	(C)	2004	2008	W/o OEM amplifier	No	AP T-H AVS01
Opel	Vivaro		2006	2011	W/o OEM amplifier	No	AP T-H AVS01
Opel	Zafira		2005	2011	W/o OEM amplifier	No	AP T-H AVS01
Opel	Zafira	Tourer	2011	2018	W/o OEM amplifier	No	AP T-H GMN01
Porsche	911	(996/997)	1998	2008	W/o OEM amplifier	Yes	AP T-H ISO01
Porsche	911	(997/991)	2009	2018	W/o OEM amplifier	No	AP T-H MBP01
Porsche	Boxster	(986/987)	1996	2008	W/o OEM amplifier	Yes	AP T-H ISO01
Porsche	Boxster	(987/981)	2009	2018	W/o OEM amplifier	No	AP T-H MBP01
Porsche	Cayenne	(9Pa)	2002	2007	W/o OEM amplifier	Yes	AP T-H ISO01
Porsche	Cayenne	(9Pa/92A)	2008	2018	W/o OEM amplifier	No	AP T-H MBP01
Porsche	Cayman	(986/987)	2006	2008	W/o OEM amplifier	Yes	AP T-H ISO01
Porsche	Cayman	(987/981)	2009	2018	W/o OEM amplifier	No	AP T-H MBP01
Porsche	Panamera	(970/971)	2009	2018	W/o OEM amplifier	No	AP T-H MBP01
Ram	1500, 2500, 3500		2012	2012	W/o OEM amplifier	No	AP T-H CHR01
Ram	1500, 2500, 3500		2013	2018	W/o OEM amplifier	No	AP T-H FCA01
Ram	3500, 4500, 5500	Chassis Cab	2012	2012	W/o OEM amplifier	No	AP T-H CHR01
Ram	3500, 4500, 5500	Chassis Cab	2013	2018	W/o 8" Screen and w/o OEM Amplifier	No	AP T-H FCA01
Ram	C/ V Tradesman		2012	2015	W/o OEM amplifier	No	AP T-H CHR01
Ram	Promaster		2014	2018	With Nav, Or 5" Screen And w/o OEM Amplifier	No	AP T-H FCA01
Renault	Avantime		2001	2003	W/o OEM amplifier	Yes	AP T-H ISO01
Renault	Clio	(III)	2005	2013	W/o OEM amplifier	Yes	AP T-H ISO01
Renault	Fluence		2010	2016	W/o OEM amplifier	Yes	AP T-H ISO01
Renault	Kangoo	(Kc)	200	2005	W/o OEM amplifier	Yes	AP T-H ISO01
Renault	Koleos		2008	2012	W/o OEM amplifier	No	AP T-H ISO01
Renault	Koleos		2008	2012	W/o OEM amplifier	No	AP T-H ISO01
Renault	Laguna	(III)	2007	2015	W/o OEM amplifier	Yes	AP T-H ISO01
Renault	Latitude		2011	2015	W/o OEM amplifier	Yes	AP T-H ISO01
Renault	Megane		2000	2005	W/o OEM amplifier	Yes	AP T-H ISO01
Renault	Scenic		2000	2005	W/o OEM amplifier	Yes	AP T-H ISO01
Renault	Trafic		2000	2005	W/o OEM amplifier	Yes	AP T-H ISO01
Renault	Vel Satis		2002	2009	W/o OEM amplifier	Yes	AP T-H ISO01
Seat	Alahambra		2011	2015	W/o OEM amplifier	No	AP T-H AVS01
Seat	Altea		2004	2014	W/o OEM amplifier	No	AP T-H AVS01
Seat	Exeo		2008	2014	W/o OEM amplifier	No	AP T-H AVS01
Seat	Ibiza		2008	2015	W/o OEM amplifier	No	AP T-H AVS01
Seat	Ibiza		2015	2018	W/o OEM amplifier	No	AP T-H AVS02
Seat	Leon		2005	2014	W/o OEM amplifier	No	AP T-H AVS01

Brand	Car Model	Chassis	From Year	To Year	Description	"ACC" Wire	AP T-HARNESS
Seat	Leon		2014	2018	W/o OEM amplifier	No	AP T-H AVS02
Seat	Mii		2012	2017	W/o OEM amplifier	No	AP T-H AVS01
Seat	Toledo		2005	2009	W/o OEM amplifier	No	AP T-H AVS01
Skoda	Citigo		2012	2017	W/o OEM amplifier	No	AP T-H AVS01
Skoda	Fabia		2007	2014	W/o OEM amplifier	No	AP T-H AVS01
Skoda	Fabia		2015	2018	W/o OEM amplifier	No	AP T-H AVS02
Skoda	Octavia		2005	2013	W/o OEM amplifier	No	AP T-H AVS01
Skoda	Octavia		2013	2018	W/o OEM amplifier	No	AP T-H AVS02
Skoda	Rapid		2009	2014	W/o OEM amplifier	No	AP T-H AVS01
Skoda	Rapid		2015	2018	W/o OEM amplifier	No	AP T-H AVS02
Skoda	Roomster		2006	2015	W/o OEM amplifier	No	AP T-H AVS01
Skoda	Superb		2001	2008	W/o OEM amplifier	Yes	AP T-H IS001
Skoda	Superb		2006	2015	W/o OEM amplifier	No	AP T-H AVS01
Skoda	Yeti		2009	2012	W/o OEM amplifier	No	AP T-H AVS01
Skoda	Yeti		2014	2018	W/o OEM amplifier	No	AP T-H AVS02
Smart	Forfour		2004	2006	W/o OEM amplifier	Yes	AP T-H IS001
Smart	Forfour		2007	2014	W/o OEM amplifier	No	AP T-H MBP01
Smart	Fortwo		2000	2007	W/o OEM amplifier	Yes	AP T-H IS001
Smart	Fortwo		2007	2014	W/o OEM amplifier	No	AP T-H MBP01
Smart	Fortwo		2015	2018	W/o OEM amplifier	No	AP T-H MBP01
Smart	Roadster		2002	2007	W/o OEM amplifier	Yes	AP T-H IS001
Subaru	BRZ		2013	2018	W/o OEM amplifier	Yes	AP T-H TOL01
Subaru	Forester	(Gr, G4)	2007	2014	W/o OEM amplifier	Yes	AP T-H INI01
Subaru	Forester		2015	2018	W/o OEM amplifier	Yes	AP T-H TOL01
Subaru	Impreza		2007	2014	W/o OEM amplifier	Yes	AP T-H INI01
Subaru	Impreza		2015	2018	W/o OEM amplifier	Yes	AP T-H TOL01
Subaru	Iq		2015	2018	W/o OEM amplifier	Yes	AP T-H TOL01
Subaru	Justy		2008	2014	W/o OEM amplifier	Yes	AP T-H TOL01
Subaru	Legacy		2009	2014	W/o OEM amplifier	Yes	AP T-H INI01
Subaru	Legacy		2015	2018	W/o OEM amplifier	Yes	AP T-H TOL01
Subaru	Outback		2010	2014	W/o OEM amplifier	Yes	AP T-H INI01
Subaru	Outback		2015	2018	W/o OEM amplifier	Yes	AP T-H TOL01
Subaru	XV		2012	2014	W/o OEM amplifier	Yes	AP T-H INI01
Subaru	XV		2015	2018	W/o OEM amplifier	Yes	AP T-H TOL01
Toyota	4Runner		2003	2018	W/o OEM amplifier	Yes	AP T-H TOL01
Toyota	Aurion		2006	2014	W/o OEM amplifier	Yes	AP T-H TOL01
Toyota	Auris		2007	2018	W/o OEM amplifier	Yes	AP T-H TOL01
Toyota	Avalon		2005	2018	W/o OEM amplifier	Yes	AP T-H TOL01
Toyota	Avensis		2009	2018	W/o OEM amplifier	Yes	AP T-H TOL01
Toyota	Avensis Verso		2001	2009	W/o OEM amplifier	Yes	AP T-H TOL01

Brand	Car Model	Chassis	From Year	To Year	Description	"ACC" Wire	AP T-HARNESS
Toyota	Aygo		2014	2018	W/o OEM amplifier	Yes	AP T-H TOL01
Toyota	Camry		2002	2018	W/o OEM amplifier	Yes	AP T-H TOL01
Toyota	Camry	Solara	2004	2008	W/o OEM amplifier	Yes	AP T-H TOL01
Toyota	Celica		2000	2005	W/o OEM amplifier	Yes	AP T-H TOL01
Toyota	Corolla	Verso	2002	2009	W/o OEM amplifier	Yes	AP T-H TOL01
Toyota	Corolla		2003	2018	W/o OEM amplifier	Yes	AP T-H TOL01
Toyota	Echo		2000	2005	W/o OEM amplifier	Yes	AP T-H TOL01
Toyota	Etios		2010	2014	W/o OEM amplifier	Yes	AP T-H TOL01
Toyota	Fj Cruiser		2007	2014	W/o OEM amplifier	Yes	AP T-H TOL01
Toyota	Fortuner		2005	2014	W/o OEM amplifier	Yes	AP T-H TOL01
Toyota	GT86		2012	2018	W/o OEM amplifier	Yes	AP T-H TOL01
Toyota	Highlander		2001	2018	W/o OEM amplifier	Yes	AP T-H TOL01
Toyota	Hi-Lux		1989	2018	W/o OEM amplifier	Yes	AP T-H TOL01
Toyota	Iq		2009	2015	W/o OEM amplifier	Yes	AP T-H TOL01
Toyota	Kluger		2001	2014	W/o OEM amplifier	Yes	AP T-H TOL01
Toyota	Land Cruiser	120/125	2002	2008	W/o OEM amplifier	Yes	AP T-H TOL01
Toyota	Land Cruiser	200	2007	2018	W/o OEM amplifier	Yes	AP T-H TOL01
Toyota	Land Cruiser	150/155	2009	2018	W/o OEM amplifier	Yes	AP T-H TOL01
Toyota	Matrix		2005	2013	W/o OEM amplifier	Yes	AP T-H TOL01
Toyota	MR2	Spyder	2000	2003	W/o OEM amplifier	Yes	AP T-H TOL01
Toyota	Prius	V	2004	2018	W/o OEM amplifier	Yes	AP T-H TOL01
Toyota	Rav4		2001	2018	W/o OEM amplifier	Yes	AP T-H TOL01
Toyota	Sequoia		2001	2018	W/o OEM amplifier	Yes	AP T-H TOL01
Toyota	Sienna		2000	2018	W/o OEM amplifier	Yes	AP T-H TOL01
Toyota	Solara		2004	2008	W/o OEM amplifier	Yes	AP T-H TOL01
Toyota	Tacoma		2000	2018	W/o OEM amplifier	Yes	AP T-H TOL01
Toyota	Tundra		2006	2018	W/o OEM amplifier	Yes	AP T-H TOL01
Toyota	Venza		2009	2018	W/o OEM amplifier	Yes	AP T-H TOL01
Toyota	Verso		2009	2018	W/o OEM amplifier	Yes	AP T-H TOL01
Toyota	Yaris		2007	2018	W/o OEM amplifier	Yes	AP T-H TOL01
Volkswagen	Amarok		2010	2014	W/o OEM amplifier	No	AP T-H AVS01
Volkswagen	Bora		2006	2013	W/o OEM amplifier	No	AP T-H AVS01
Volkswagen	Caddy		2005	2015	W/o OEM amplifier	No	AP T-H AVS01
Volkswagen	Caddy		2015	2018	W/o OEM amplifier	No	AP T-H AVS02
Volkswagen	California	(T5)	2003	2014	W/o OEM amplifier	No	AP T-H AVS01
Volkswagen	Caravelle		2009	2014	W/o OEM amplifier	No	AP T-H AVS01
Volkswagen	Crafter		2006	2016	W/o OEM amplifier	No	AP T-H AVS01
Volkswagen	Crafter		2017	2018	W/o OEM amplifier	No	AP T-H AVS02
Volkswagen	Eos		2008	2016	W/o OEM amplifier	No	AP T-H AVS01
Volkswagen	Fox		2004	2010	W/o OEM amplifier	No	AP T-H AVS01

Brand	Car Model	Chassis	From Year	To Year	Description	"ACC" Wire	AP T-HARNESS
Volkswagen	Golf Plus		2004	2008	W/o OEM amplifier	No	AP T-H AVS01
Volkswagen	Golf Sportvan		2015	2018	W/o OEM amplifier	No	AP T-H AVS02
Volkswagen	Golf	V	2004	2008	W/o OEM amplifier	No	AP T-H AVS01
Volkswagen	Golf	VI	2008	2013	W/o OEM amplifier	No	AP T-H AVS01
Volkswagen	Golf	VII	2014	2018	W/o OEM amplifier	No	AP T-H AVS02
Volkswagen	Jetta		2006	2015	W/o OEM amplifier	No	AP T-H AVS01
Volkswagen	Maggiolino		2011	2015	W/o OEM amplifier	No	AP T-H AVS01
Volkswagen	Maggiolino		2015	2018	W/o OEM amplifier	No	AP T-H AVS02
Volkswagen	Passat		2008	2014	W/o OEM amplifier	No	AP T-H AVS01
Volkswagen	Passat		2015	2018	W/o OEM amplifier	No	AP T-H AVS02
Volkswagen	Passat CC		2008	2014	W/o OEM amplifier	No	AP T-H AVS01
Volkswagen	Phaeton		2010	2014	W/o OEM amplifier	No	AP T-H AVS01
Volkswagen	Polo	V	2005	2010	W/o OEM amplifier	No	AP T-H AVS01
Volkswagen	Polo	VI	2010	2014	W/o OEM amplifier	No	AP T-H AVS01
Volkswagen	Polo	VII	2015	2018	W/o OEM amplifier	No	AP T-H AVS02
Volkswagen	Rabbit		2003	2014	W/o OEM amplifier	No	AP T-H AVS01
Volkswagen	Routan		2009	2013	W/o OEM amplifier	No	AP T-H CHR01
Volkswagen	Scirocco		2008	2014	W/o OEM amplifier	No	AP T-H AVS01
Volkswagen	Sharan		2011	2014	W/o OEM amplifier	No	AP T-H AVS01
Volkswagen	Sharan		2015	2018	W/o OEM amplifier	No	AP T-H AVS02
Volkswagen	Tiguan		2004	2015	W/o OEM amplifier	No	AP T-H AVS01
Volkswagen	Tiguan		2015	2018	W/o OEM amplifier	No	AP T-H AVS02
Volkswagen	Touareg		2004	2014	W/o OEM amplifier	No	AP T-H AVS01
Volkswagen	Touran		2003	2015	W/o OEM amplifier	No	AP T-H AVS01
Volkswagen	Transporter	T5	2004	2015	W/o OEM amplifier	No	AP T-H AVS01
Volkswagen	Up!		2012	2015	W/o OEM amplifier	No	AP T-H AVS01
Volkswagen	Up!		2016	2018	W/o OEM amplifier	No	AP T-H AVS02
Volkswagen	Vento		2009	2014	W/o OEM amplifier	No	AP T-H AVS01

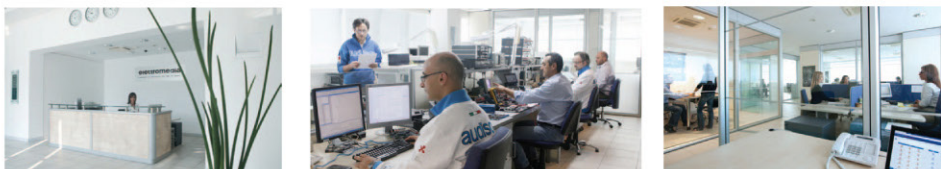

ABOUT US

Elettromedia, an Italian company, is a leader within the world-wide car Hi-Fi market. Born in 1987 in Potenza Picena by a group of friends who shared the same passion for in-car high fidelity, throughout the past years Elettromedia has been walking the path of excellence: its products are distributed in more than 50 countries; the company has received many awards and acknowledgements from the most authoritative leaders within the car audio industry; it also can boast reviews of more than 3000 pages published in 30 different languages (visit: www.elettromedia.it/press_area.asp).

The Elettromedia brands are Audison, Hertz, Connection and AZaudiocomp. Through a co-branding strategy, the company offers all of the components required for a complete, top-level car audio system.

CONTACTS:

Elettromedia s.r.l. Strada Regina km 3,500 - 62018 Potenza Picena (Mc) - Italy
 T +39 0733 870 870 - F +39 0733 870 880 - www.elettromedia.it

AWARDS

Materiali disponibili

PRIMA Product Information (versionePDF, risoluzione 150 dpi)

LOGHI: Audison, PRIMA, Plug & Sound, Bit drive, Full DA, KLIPPEL,
(versione Adobe Illustrator, risoluzione 300 dpi)

FOTO (versione JPEG, risoluzione 300 dpi)



AP Speaker OUT Cable



AP Speaker OUT Cable



AP Speaker OUT Cable



AP Extension cable IN/OUT

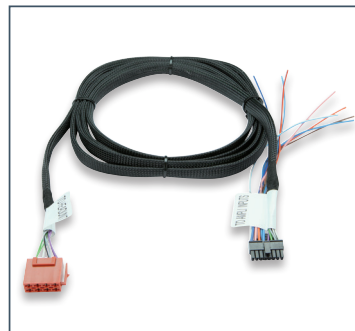

AP Extension cable IN

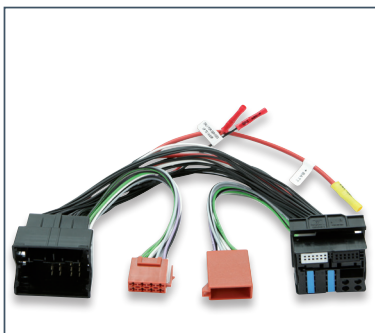

AP T-Harness ("AP T-H AVS01" in the picture)



All specifications subject to change without notice

www.audison.eu

audison
ISTINTO
INNOVATIVO

PART OF ELETTROMEDIA
62018 Potenza Picena (MC) Italy
T +39 0733 870 870 - F +39 0733 870 880
www.elettromedia.it